

Miele

HONEYCOMB CARE

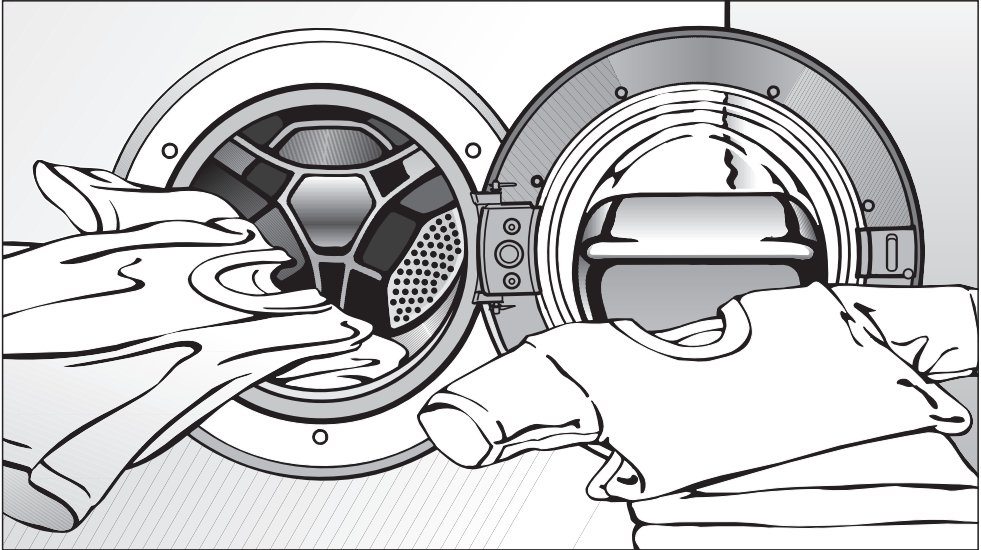

Operating instructions Washer-dryer WT 2670

To avoid the risk of accidents
or damage to the machine
it is **essential** to read
these instructions before it is
installed and used for the first time.

en - GB

M.-Nr. 06 717 280

Caring for the environment

Disposal of the packing material

The transport and protective packing has been selected from materials which are environmentally friendly for disposal and can normally be recycled.

Ensure that any plastic wrappings, bags etc. are disposed safely and kept out of the reach of babies and young children. Danger of suffocation!

Rather than just throwing these materials away, please ensure they are offered for recycling.

Disposal of your old appliance

Electrical and electronic appliances often contain materials which, if handled or disposed of incorrectly, could be potentially hazardous to human health and to the environment. They are, however, essential for the correct functioning of your appliance or machine. Please do not therefore dispose of it with your household waste.

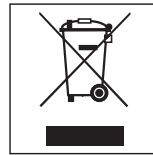



Please dispose of it at your local community waste collection / recycling centre or contact your Dealer for advice. Ensure that it presents no danger to children while being stored for disposal.

It should be unplugged or disconnected from the mains electricity supply by a competent person.

Caring for the environment	2
Warning and safety instructions	6
Guide to the machine	11
Control panel	11
Display	12
Use	12
Before using for the first time	13
Calibrating the load size sensor to zero	14
Washing and drying environmentally	15
WASHING	16
Brief instructions	16
Separate washing	16
Extra options	21
Pre-wash	21
Soak	21
Short	21
Water plus	21
Buzzer	21
Adding or removing laundry after a programme has started	22
Spinning	23
Rinse and interim spin	23
To omit the final spin (Rinse hold)	23
To omit rinse and interim spin and the final spin	23
Programme chart	24
Programme sequence	28
Garment care label symbols	30
Detergent	30
Water softeners	31
Washing with several components	31
Fabric conditioners or liquid starch	32
Automatic dispensing of fabric conditioner or liquid starch to laundry at the end of a programme	32
Adding fabric conditioner separately	32
Adding starch separately	32
Colour run and dye removers / dyes	32

Contents

DRYING	33
Separate drying	33
Extra option	36
Low temperature	36
Thermospin	36
Adding or removing laundry after a programme has started.	36
Programme chart	37
WASHING AND DRYING	41
Washing and drying in a continuous sequence	41
After each washing or drying programme.	43
Rinse out fluff programme.	43
Changing the programme sequence	44
Cancelling a programme	44
Interrupting a programme.	44
Altering a programme.	44
Electronic programme locking	45
Delay start.	46
Cleaning and care	47
Cleaning the machine	47
Cleaning the filter in the water inlet	49
Problem solving guide	50
What to do, if	50
The programme does not start.	50
Fault messages in the display	51
Problems with the load size indicator	52
General problems	53
An unsatisfactory wash result	54
An unsatisfactory drying result	55
The drum door cannot be opened by pressing the <i>Door</i> button	56
Opening the drum door in the event of a blocked drain outlet and/or power failure.	57
After sales service	60
Future updates (PC)	60
Appliance guarantee	60
Optional accessories	60

Installation and connection	61
Front view	61
Rear view	62
Installation surface	63
Installing the washer-dryer	63
Removing the transit fittings	63
Levelling the machine	65
Screwing out and adjusting the feet	66
Building under a continuous worktop / in a kitchen run	66
The Miele water protection system	67
Connection to the water supply	68
Connection to the drainage system	69
Electrical connection U.K.	70
Consumption data	71
Note for test institutes:	71
Technical data	72
Settings menu 	73
Language 	73
Time of day	74
Water plus	74
Gentle action	75
Suds cooling	75
Door release	75
Distribution controller	76
Alter time	76
Lock	77
Temperature	78
Buzzer	78
Keypad tones	78
Display contrast	78
Display brightness	78
Standby	79
Memory	79
Set extended cool-down	79

Warning and safety instructions

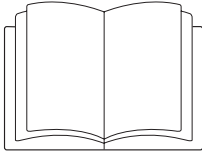

► It is **essential** to read these instructions.

This washer-dryer conforms to current safety requirements. Inappropriate use can, however, lead to personal injury and damage to property.

To avoid the risk of accidents and damage to the washer-dryer, please read these instructions carefully before using it for the first time. They contain important information on its installation, safety, use and maintenance.

Keep these instructions in a safe place and ensure that new users are familiar with the content. Pass them on to any future owner.

Correct application

► This washer-dryer must only be used:

- to wash items which are specified by the manufacturer to be washable on the care label.
- to dry textiles which have been washed in a water solution, marked on the manufacturer's wash care label as being suitable for tumble drying. "Dry cleaning kits" for freshening up garments in a tumble dryer are increasingly available on

the market. If using, do so at your own risk, and follow the instructions provided on the packaging.

Any other applications may be dangerous. Miele cannot be held liable for damage resulting from incorrect or improper use or operation.

► This washer-dryer is not intended for use by persons (including children) with reduced physical, sensory or mental capabilities, or lack of experience and knowledge, unless they are supervised whilst using it or have been shown how to use it correctly by a person responsible for their safety.

Safety with children

► Keep children away from the washer dryer at all times. It is not a toy! To avoid the risk of injury do not allow children to play on or near it or to play with its controls. Supervise children whilst you are using it.

► Older children may only use the washer dryer if its operation has been clearly explained to them and they are able to use it safely, recognising the dangers or misuse.

Technical safety

► Before setting up the washer-dryer, check it for any externally visible damage.

Do not install or use a damaged machine.

► Before connecting the washer-dryer, ensure that the connection data on the data plate (voltage and connected load) match the mains electricity supply. If in any doubt, consult a qualified electrician.

► The electrical safety of this washer-dryer can only be guaranteed when continuity is complete between it and an effective earthing system which complies with current local and national safety regulations. It is most important that this basic safety requirement is present and regularly tested, and where there is any doubt the household wiring system should be inspected by a qualified electrician. The manufacturer cannot be held liable for the consequences of an inadequate earthing system (e.g. electric shock).

► Do not connect the machine to the mains electricity supply by an extension lead. Extension leads do not guarantee the required safety of the washer-dryer (e.g. danger of overheating).

► Unauthorised repairs could result in unforeseen dangers for the user, for which the Miele cannot accept liability. Repairs should only be undertaken by a Miele approved service technician. Ensure current is not supplied to the machine until after maintenance or repair work has been carried out.

► In the event of a fault or for cleaning purposes, the washer-dryer is only completely isolated from the electricity supply when:

- it is switched off at the wall socket and the plug is withdrawn, or
- it is switched off at the mains, or
- the mains fuse is disconnected, or the screw-out fuse is removed (in countries where this is applicable).

► This washer-dryer must only be connected to the on-site water supply using a new hose kit. Old hoses must not be re-used.

► Faulty components must only be replaced by genuine Miele original spare parts. Only when these parts are fitted can the safety standards of the machine be guaranteed.

► If the connection cable is faulty it must only be replaced by a Miele approved service technician to protect the user from danger.

Warning and safety instructions

▶ This washer-dryer may only be used in mobile installations such as ships if a risk assessment of the installation has been carried out by a suitably qualified engineer.

▶ In countries where there are areas which may be subject to infestation by cockroaches or other vermin, pay particular attention to keeping the machine and its surroundings in a clean condition at all times. Any damage which may be caused by cockroaches or other vermin will not be covered by the guarantee.

▶ Do not make any alterations to the washer-dryer, unless authorised to do so by Miele.

Correct use

▶ Do not install your washer-dryer in rooms where temperatures below freezing may occur. Frozen hoses may burst or split. The reliability of the electronic control unit may be impaired at temperatures below freezing point.

▶ Before using the washer-dryer for the first time, check that the transit bars at the rear of the machine have been removed (see section on "Installation"). During spinning, a transit fitting which is still in place may result in damage to both the machine and adjacent furniture or appliances.

▶ Turn off the stopcock if the machine is to be left for any length of time (e.g. holiday), especially if there is no floor drain (gully) in the immediate vicinity.

▶ Flooding danger.

If hooking the drain hose into a wash basin, check that the water can drain off quickly enough to prevent the sink from overflowing. Make sure the drain hose is secure, so that the force of the water flowing out of the hose does not dislodge it.

▶ Take care to ensure that foreign objects (e.g. nails, pins, coins, paper clips) do not find their way into the machine with the laundry. These may damage components of the machine (e.g. suds container, drum), which in turn can result in damage to the laundry.

▶ If the correct amount of detergent is dispensed, the machine should not need to be descaled. If, however, you do wish to descale the machine only use proprietary non-corrosive descaling agents and strictly observe the instructions on the packaging. A Miele descaling agent is available to order (see "Cleaning and care").

Warning and safety instructions

► To prevent the risk of fire, the following must not be dried in this washer-dryer:

- items which have not been washed.
- items, such as workwear, which have not been thoroughly cleaned and which are still soiled with grease, oil or other desposits (such as cosmetics, lotions etc).
If items have not been thoroughly cleaned there is a danger that these might ignite when heated, even after they have been removed from the washer-dryer at the end of the programme.
- items which have been treated with inflammable cleaning agents or contain residues of acetone, alcohol, benzine, petrol, stain remover, turpentine, wax, wax remover or other chemicals (e.g. mops and floor cloths).
- items which have been splashed with hair lacquer, hair spray, nail varnish remover or similar substances.

When washing such heavily soiled items, ensure that you use sufficient detergent and select a high temperature. If in doubt, wash the items several times.

► To prevent the risk of fire, the following must not be dried in this washer-dryer:

- fabrics which contain a large proportion of rubber, foam rubber or rubber-like materials. For example, products made from latex foam rubber, shower caps, waterproof textiles, rubberised articles and items of clothing and pillows with foam rubber filling.
- items which contain padding or fillings (e.g. pillows, jackets). If these were damaged the filling could get out with the risk of igniting in the washer-dryer.

► In many programmes, the heating phase is followed by a cooling down phase to ensure that the items are not too hot to handle when you remove them (this also avoids the danger of the laundry self-igniting). The programme is not finished until the cooling down phase has been completed. Ensure that you always wait until the end of the programme before removing the laundry.

► **Warning:** Do not switch the washer-dryer off before the end of a drying programme. If this was done and the laundry was then removed immediately it could give off a great amount of heat.

► Fabric conditioner and similar products must be used according to the instructions on the manufacturer's packaging.

Warning and safety instructions

▶ Only use dyes specified by the manufacturer as being suitable for use in a domestic washing machine. Always observe the manufacturer's instructions carefully.

▶ Colour run and dye removers contain sulphur compounds which can cause damage such as corrosion. Do not use these products in this machine.

▶ Make sure that any dispensing balls etc. are removed from laundry before the drying programme. These dispensers can melt during the drying programme and cause damage to the machine and the laundry. Do not use liquid dispenser balls or similar if you are planning to wash and then dry in one continuous sequence.

▶ Textiles which have been pre-treated in solvent based cleaning agents must be thoroughly rinsed in clean water before being washed in the washer-dryer.

▶ Never use solvent based cleaning agents, e.g. those containing benzene, in this machine, as this may result in damage to component parts and create toxic fumes. Such agents also pose a fire and explosion hazard.

▶ **Take care, the metal cap is hot after drying.**

Open the door wide after the drying cycle. Do not touch the metal cap located on the inside of the door glass. It will still be hot and could cause a burn.

Accessories

▶ Accessory parts may only be fitted when expressly approved by Miele. If other parts are used, guarantee, performance and product liability claims will be invalidated.

Miele cannot be held liable for damage caused by non-compliance with these Warning and Safety instructions.

Control panel

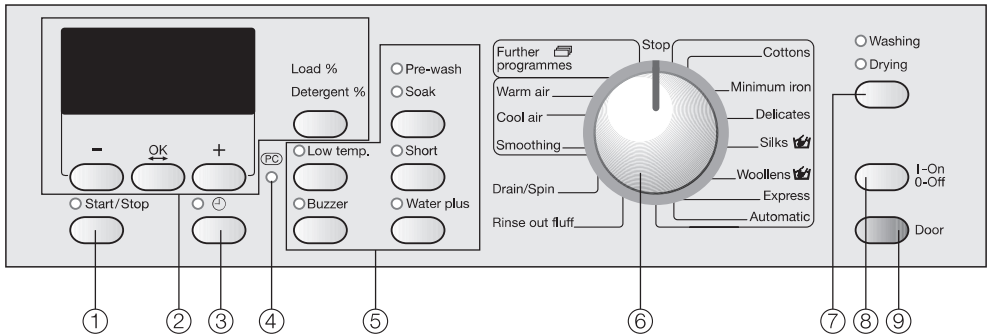

① **Start/Stop button**

For starting the programme selected and cancelling a programme once it has started.

② **Display with – , OK, + and Load/Detergent buttons**

See the following page for more details.

③ **⌚ button**

For selecting delay start and setting the time of day.

④ **PC / Optical interface**

This is used by service technicians to run diagnostic checks on your machine and can also be used to update programming data in the future.

⑤ **Extra option buttons**

with indicator lights
Various extra options can be added to the programmes.

⑥ **Programme selector**

For selecting washing and drying programmes. The programme selector can be turned clockwise or anti-clockwise.

⑦ **Washing/Drying button**

for selecting:

- Washing
- Drying
- Washing **and** Drying.

⑧ **I-On/O-Off button**

For switching the washer-dryer on and off.

⑨ **Door button**

Opens the machine door.

Guide to the machine

Display

When a programme is selected the display can be used to select and change programme parameters.

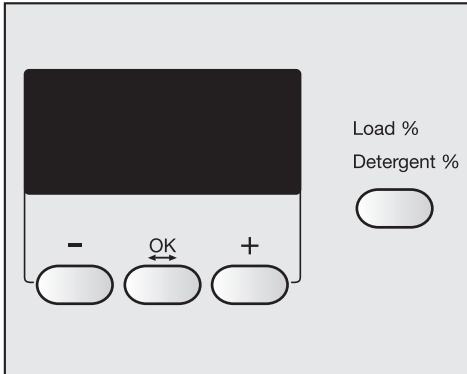

- / + buttons

For altering the parameters highlighted in the display:

- decreases the parameter or moves the highlighting upwards
- + increases the parameter or moves the highlighting downwards.

OK button

For confirming the parameter selected and choosing the next parameter.

Load/Detergent button

For calling up the load size and the detergent amount.

With the programme selector at the *Further programmes* position, you can select the following programmes via the display: *Dark garments, Shirts, Denim, Sportswear, Outerwear, Proofing, Curtains, Separate rinse* and *Starch*.

Delay start and the soak time are selected via the display.

The display shows the duration of the programmes and the current time of day.

The *Settings*  menu is also operated via the display.

Use

This washer-dryer can be used:

- **to wash separately**
max. load 5 kg (depending on programme);
- **to dry separately**
max. load 2.5 kg (depending on programme);
- or
- **to wash and dry in a continuous sequence**
max. load 2.5 kg (depending on programme).

Before using for the first time

Before using the machine for the first time ensure that it is correctly installed and connected. See "Installation and connection". Also check that the drain filter is securely tightened to prevent the risk of water leaks during use.

The washer-dryer has a sensor which measures the amount of laundry in the drum. This determines the amount of detergent required. To allow the load size indicator to function correctly, you must first run a wash programme without any laundry and without detergent.

- Open the stopcock.
- Press the *I-On/O-Off* button in.

If the washer-dryer is being switched on for the first time, the welcome screen will appear.



The welcome screen will not appear again once a programme lasting longer than 1 hour has been completed.

After a few seconds the display will change to show the screen for selecting your language.

Setting the language

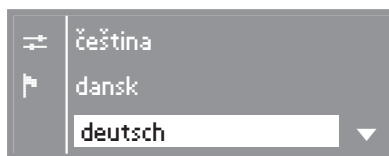

- Use the – and + buttons to select the language you want and confirm your selection by pressing the **OK** button.

Setting the time of day

The display for setting the time will appear.



- Set the hour with the – and + buttons and confirm your setting by pressing the **OK** button. Now set the minutes. After you have confirmed the minute setting, the display will change to show the reminder to remove the transport struts.

Before using for the first time

Reminder to remove transport struts

To avoid the risk of damage, the transport struts must be removed before the washer-dryer is used for the first time. See "Installation and connection" for instructions on how to do this.



Remove transport struts

OK

- After removing the transport struts (if this has not already been done by your fitter) press the **OK** button.

Running your first programme

Your washer-dryer is now ready for the first programme to be run.

15:00

Select programme

- Turn the programme selector to the *Cottons* position.
- Press the *Start/Stop* button.
- When the programme has finished, turn the programme selector to *Stop* and switch off the washer-dryer.

The load sensor must then be calibrated to zero as you would with bathroom scales.

Calibrating the load size sensor to zero

- Switch the machine on.
- Open the drum door.
- Turn the programme selector to the *Cottons* position.
- Press and hold the *Load/Detergent* button pressed in until the following message appears in the display:



Zero setting
OK

- Turn the programme selector to *Stop* and switch off the washer-dryer.

The machine is now ready for use.

Washing and drying environmentally

Energy and water consumption

- Water consumption and energy usage are determined by the size of the load.
To make the most out of your machine, load the maximum dry load for the programme you are using.
- Use the *Automatic* and *Express* programmes for small loads.
- When smaller amounts of laundry are washed using the *Cottons* programmes, the automatic load recognition system will reduce the amount of water, time and energy used. This may mean that the programme duration is adjusted during the course of the wash programme.
- Using the *Cottons* 60°C programme instead of the *Cottons* 95°C programme will give energy savings of between 35% and 45%. This is sufficient for most levels of soiling. For stubborn or old stains, use the *Soak* extra option.

Detergent

- Do not exceed the amounts of detergent recommended by the manufacturer on the packaging.
- Reduce the amount of detergent for smaller loads. Use the *Load/Detergent* button.

Choosing the correct extra option (Pre-wash, Soak, Short)

Select:

A wash programme together with the *Short* extra option for light to normal soiling where there are no obvious marks.

A wash programme without any extra options for normal to heavy soiling.

A wash programme together with the *Soak* option for heavily soiled laundry.

- Use the extra option *Soak* instead of *Pre-wash*. If *Soak* is followed immediately by a main wash, the same suds are used.

When drying straight afterwards

- Select a high spin speed for the wash programme, as well as for the Thermospin, if tumble drying this laundry afterwards. This saves time and energy.

WASHING

Brief instructions

The headings numbered ①, ②, ③, . . . show the operating sequence and can be used as brief instructions.

Separate washing

① Sort the laundry

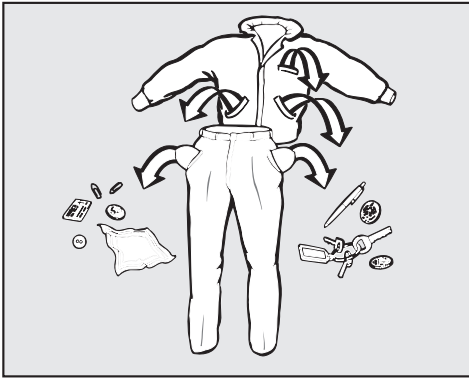

- Empty all pockets.

⚠ Foreign objects (e.g. nails, coins, paper clips, etc.) can cause damage to garments and components in the machine.

- Badly soiled areas, stains etc. should be cleaned as soon as possible, preferably whilst still fresh. Spillages should be carefully dabbed off using a soft colourfast cloth. Do not rub!

Badly soiled areas can be pre-treated with liquid detergent, stain removers etc. first, following the manufacturer's instructions. With particularly stubborn stains ask your dry cleaner for advice.

⚠ Do not use solvent-based cleaning agents in this machine.

- Sort the laundry by colour and by care label. Most garments have a textile care label in the collar or side seam.

Dark textiles often contain excess dye and should be washed separately several times before being included in a mixed load. Always wash whites and coloureds separately.

- Curtains: Remove lead weights first or place in a laundry bag.
- Underwiring and collar stiffeners: Any loose wiring in bras, shirt collar stiffeners, etc. should be removed or sewn in.
- Knitted garments, trousers and jeans, T-shirts and sweat shirts: Turn inside out, if recommended by the manufacturer.
- Close any zips, fasten hooks and eyes etc before washing.
- Fasten duvet covers and pillow cases to prevent small items from being trapped inside them.

Do not wash any items in this machine which are specified by the manufacturer as **non-machine washable** on the care label. (☒ symbol)

2 Switch the machine on

The interior drum lighting will come on.

3 Select a programme

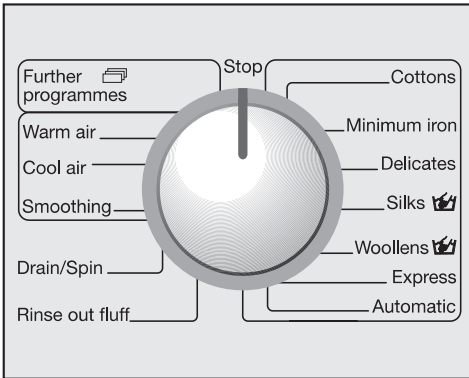

- Select the programme you want.

The programme selected will appear in the display.



Further programmes:

When you turn the programme selector to *Further programmes*, a list of these programmes will appear in the display.

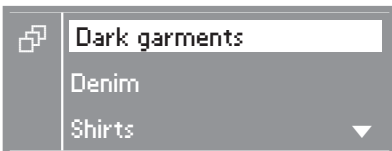

- Use the - or + button to highlight the programme you wish to select and confirm your selection by pressing the **OK** button.

Wait until the display switches to show the menu for the programme selected.



or



- Press the *Washing/Drying* button repeatedly until **only** the Washing indicator light is lit up.

The *Drying* indicator light must not be lit up as well as this would mean that the washing programme would be followed immediately by the drying programme.

- You can alter the highlighted temperature with the - or + buttons. Press the **OK** button to confirm the temperature you want and move on to the spin speed.



- You can then alter the highlighted spin speed, select *rinse hold* or *without spin* with the - or + buttons.

WASHING

- You can select any extras options with the extra option buttons.

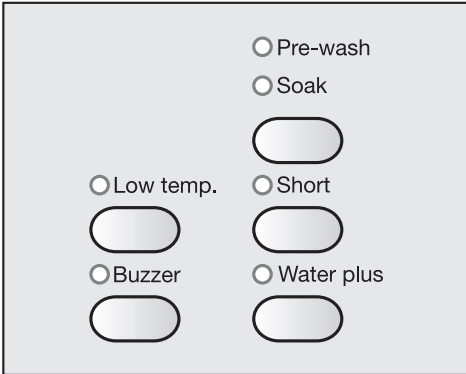

- Each press of the top right hand button selects the extra option in the following order: *Pre-wash* or *Soak* or no option is selected.

Not all the extra options are suitable for use with every wash programme.

You can only select extra options which are compatible with the basic programme being used.

The *Low temperature* extra only applies to drying.

- Select Delay start, if required.

4 Load the drum

- Press the *Door* button to open the drum door.

The load size indicator display will appear.

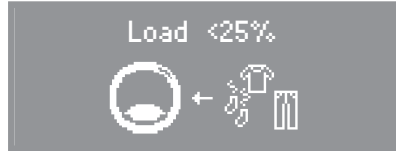

The display shows the amount of laundry loaded in the drum as a % (in 25% steps) of the maximum load permissible for the programme selected.

- Unfold the laundry and load loosely in the drum. Mixing both large and small items gives better wash results and also helps distribute the load evenly during spinning.

The most efficient use of energy and water is achieved when a full load is washed. However, do not overload as this causes creases and reduces cleaning efficiency.

Make sure that no garments are caught between the drum door and seal.

- Shut the door with a gentle swing.

5 Add detergent

The load size indicator display will be replaced with the detergent percentage display.

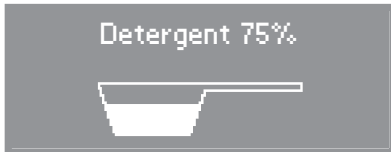

40%	Add slightly less than half the amount recommended . . .
50%	Add half the amount recommended . . .
60%	Add slightly more than half the amount recommended . . .
75%	Add three quarters of the amount recommended . . .
100%	Add the full amount

You also need to take the level of soiling and water hardness into account.

too little detergent results in:

- Laundry not getting properly clean and with time it may become grey and hard to the touch.
- Greasy particles clinging to the laundry.
- Limescale deposits on the heater elements.

too much detergent results in:

- Excessive foam which causes a low level of agitation and poor wash, rinse and spin results.

- High water consumption (an additional rinse cycle will automatically switch in).
- A burden to the environment.

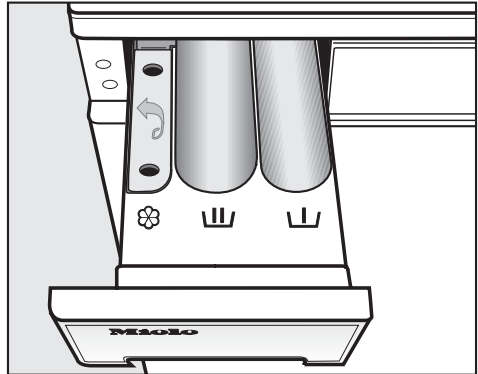

- Pull out the detergent drawer and add detergent to the compartments as follows:

 = Detergent for the pre-wash ($\frac{1}{4}$ of the total amount recommended). This compartment is also used for starch formulations when starching separately.

 = Detergent for the main wash including Soak

 = Fabric conditioner or liquid starch

- Close the detergent drawer.

See "Detergent" for further information.

WASHING

6 Start the programme

- Press the flashing *Start/Stop* button.

The estimated programme duration will count down in the display in one minute steps. During the first 10 minutes the machine measures how much water is being absorbed by the laundry. The programme duration may be longer or shorter depending on this absorbency rate.

The programme sequence is also shown in the display. The washer-dryer shows you when each section of the programme is reached.

The drum lighting switches off once the programme has started.

7 Remove the laundry when the programme has finished

In the anti-crease phase after the programme has finished, the following will appear alternately in the display:

Anti-crease

and



Programme finished.
Remove laundry, then
switch the machine off.

- Turn the programme selector to the *Stop* position. Press the *Door* button to open the drum door.

- Remove the laundry.

Only remove laundry from the machine once the drum has stopped turning. Reaching into a moving drum is extremely dangerous and could result in injury.

Check that all items have been removed from the drum. Items left in the drum could discolour other items in the next wash or become discoloured themselves.

Important! Always remove the laundry before switching the machine off. This is important to ensure that the load size indicator works correctly.

- Switch the machine off with the *I-On/O-Off* button.

See "After each washing or drying programme" for further information.

After washing a full load

If you have washed a full load of laundry and you wish to dry the laundry in the washer-dryer afterwards you will have to remove half the load. Carry out the drying procedure in two batches.

Extra options

You can use the *Extra option* buttons to augment the basic wash programmes.

Pre-wash

For laundry with large amounts of dirt (e.g. dust, sand).

Soak

For heavily soiled and stained items with protein stains (e.g. blood, fats and oils, cocoa).

A length of time of between 30 minutes and 6 hours can be chosen, in 30 minute periods for the "Soak" process.

To select the soak time

- After selecting a programme, press the *Pre-wash/Soak* button repeatedly until the *Soak* indicator light comes on.

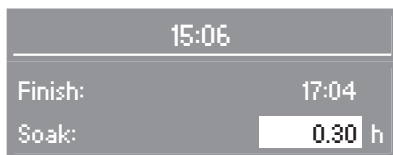

Use the **-** and **+** buttons to enter the soak time. The display will also show the corresponding finishing time for the washing programme. Press the **OK** button to confirm the soak time you want.

To delete the soak time

- Set the soak time to 0.00 h and confirm this with the **OK** button.

Short

For light to normal soiling with no visible staining.

The duration of the main wash is reduced.

Water plus

The machine is set at the factory so that the water level in the main wash and rinses will be increased if the *Water plus* extra option is selected.

However, you can select other settings for *Water plus*. These are described in "Settings menu **F**".

Buzzer

An audible tone sounds repeatedly at the end of a programme or when Rinse hold is reached.

The buzzer will sound repeatedly until the machine is switched off.

Once switched on, the buzzer is active in all programmes until it is switched off again.

You can switch the buzzer off by pressing the buzzer button. You can also change the volume of the buzzer. These are described in "Settings **F**".

The buzzer will always sound when there is a fault, even if the buzzer has been switched off.

WASHING

Adding or removing laundry after a programme has started

Laundry can be added or removed after the programme has started when using the following programmes:

- Cottons
- Minimum iron
- Automatic
- Express
- Starch

- Press the *Door* button to open the drum door.

 **Warning: The water in the machine will be very hot and could cause burning or scalding.**

- Add or remove items.
- Close the drum door.

The programme will continue automatically.

Please note:

Once a programme has started the machine cannot recognise any adjustment to the load.

For this reason, if laundry is added or removed after the start of a programme, the machine will always complete the programme cycle assuming a full load which can lead to an increase in the programme duration shown in the display.

The door cannot be opened, if:

- the suds temperature is above a certain temperature (see "Settings menu - Door release").
- the water is above a certain level (e.g. when the *Water plus* extra option has been selected).
- the programme has reached the *Final spin* stage.
- the electronic programme locking has been activated.

Spinning

The maximum final spin speed depends on the programme chosen.

Programme	rpm
Cottons	1600
Minimum iron	1200
Delicates	600
Silks	400
Woollens	1200
Express	1600
Automatic	1200
Dark garments	1200
Shirts	600
Denim	900
Sportswear	1200
Outerwear	800
Proofing	1000
Curtains	600
Separate rinse	1200
Starch	1500
Drain/Spin	1600

You can reduce the final spin speed. However, you cannot select a final spin speed higher than that shown in the chart above.

Rinse and interim spin

There is a spin after the main wash and between the rinses. A reduction in the final spin speed will also reduce the interim spin speed. If a spin speed of less than 700 rpm is selected for a *Cottons* programme, an additional rinse is introduced.

To omit the final spin (Rinse hold)

- While the spin speed is highlighted in the display, press the minus (-) button repeatedly to call up the *Rinse hold* setting and then press **OK** to confirm your selection.

The laundry will not be spun and will remain suspended in the final rinse water. This reduces creasing if the laundry is not going to be removed from the drum immediately after the end of the programme.

- To start the final spin:

The machine will display the maximum spin speed possible. You can select a spin speed lower than this. Start the final spin by pressing the *Start/Stop* button.

- To end the programme:

Press the *Door* button. The water will drain away. Press the *Door* button again to open the door.















To omit rinse and interim spin and the final spin

- While the spin speed is highlighted in the display, press the minus (-) button repeatedly to call up the *Without spin* setting and then press **OK** to confirm your selection.







The laundry is not spun after the final rinse. The water will drain away and the machine will go straight into the anti-crease stage. An additional rinse is introduced if this setting is selected with the *Cottons*, *Minimum iron*, *Express* and *Automatic* programmes.

WASHING

Programme chart

Cottons 30°C to 95°C    		max. 5.0 kg
Fabric type	Cottons, linens or cotton mix fabrics.	
Extra options	Pre-wash or Soak, Short, Water plus	
Detergent	Powder detergent, detergent for coloured fabrics, liquid detergent, tablet detergent and liquid tab detergent.	
Minimum iron 30°C to 60°C      		max. 2.5 kg
Fabric type	Synthetics, mixed fibres and easy care cottons. If fabrics have a high proportion of man-made fibres it is advisable to programme the machine for "Gentle action". See "Settings menu  ".	
Extra options	Pre-wash or Soak, Short, Water plus	
Detergent	Powder detergent, detergent for coloured fabrics, liquid detergent, detergent for delicates, tablet detergent and liquid tab detergent.	
Delicates cold to 60°C   		max. 1.0 kg
Fabric type	For delicate garments made of synthetic fibres, mixed fibres, rayon and easy care cottons.	
Extra options	Pre-wash or Soak, Short	
Detergent	Liquid detergent for delicates.	

WASHING

Silks  cold to 30°C 		max. 1.0 kg
Fabric type	Silks and other handwashable fabrics with no wool content, e.g. satin, lace and silk.	
Note	Place socks, tights, bras etc. in a washing bag.	
Extra option	Water plus	
Detergent	Liquid detergent for delicates.	
Woollens  cold to 40°C  		max. 2.0 kg
Fabric type	Machine-washable or hand-washable wool or wool blend fabrics. If the care label does not specify a temperature, wash using the cold setting.	
Detergent	Liquid detergent for machine-washable woollens.	
Express cold to 40°C  		max. 2.5 kg
Fabric type	Small loads of items which require freshening up and which can be washed in the <i>Cottons</i> programme.	
Extra option	Water plus	
Detergent	Powder detergent, detergent for coloured fabrics, liquid detergent.	

WASHING

Automatic cold to 40°C 		max. 2.5 kg
Fabric type	Mixed loads of garments suitable for the <i>Cottons</i> and <i>Minimum iron</i> programmes. Sort according to colour.	
Extra option	Pre-wash or Soak, Short, Water plus	
Detergent	Powder detergent, detergent for coloured fabrics, liquid detergent.	
Dark garments cold to 40°C		max. 2.5 kg
Garment	Dark garments made from cotton or mixed fibres.	
Note	Wash inside out.	
Detergent	Liquid detergent for coloured fabrics.	
Shirts cold to 60°C		max. 2.0 kg
Notes	<ul style="list-style-type: none"> – Pre-treat collars and cuffs if necessary. – Wash silk garments in the <i>Silks</i> programme. 	
Detergent	Powder detergent, detergent for coloured fabrics, liquid detergent.	
Denim cold to 40°C		max. 2.5 kg
Notes	<ul style="list-style-type: none"> – Wash denim inside out. – Denim often contains excess dye and will run during the first few washes. Wash light and dark coloured items separately. 	
Detergent	Liquid detergent for coloured fabrics.	
Sportswear 30°C to 60°C		max. 2.0 kg
Garment	Lightly soiled sports garments which require washing or freshening up.	
Detergent	Powder detergent, detergent for coloured fabrics, liquid detergent.	
Outerwear cold to 40°C		max. 2.0 kg
Garment	Outerwear made from micro-fibres such as Gore-Tex [®] , SYMPATEX [®] , WINDSTOPPER [®] etc.	
Notes	<ul style="list-style-type: none"> – Zip up jackets before washing. – Do not use fabric conditioner. 	
Detergent	Specialist or liquid detergent for delicates.	

WASHING

Proofing 40°C		max. 3.0 kg
Item	For treating microfibre fabrics, skiwear, fine, closeweave cotton garments (poplin) or tablecloths to provide a water and dirt resistant finish.	
Notes	<ul style="list-style-type: none"> – The items should be freshly washed and spun or dried before proofing. – For best results, the items should be heat-treated afterwards, either in a tumble dryer or by ironing. 	
Proofing agent	<ul style="list-style-type: none"> – Only use proofing agents which are stated by the manufacturer as being "suitable for use on membrane textiles" as these consist of fluorochemical compounds. Do not use proofing agents which contain paraffin. – Add proofing agents to compartment ☒. 	
Curtains cold to 40°C		max. 2.0 kg
Item	Curtains, including net curtains, specified as machine-washable by the manufacturer. A Pre-rinse without detergent is carried out automatically to remove dust.	
Note	For curtains which crease easily, reduce the spin speed or select Without spin.	
Extra option	Water plus	
Detergent	All purpose powder detergent, powder detergent for coloured fabrics or detergent specifically designed for washing curtains.	
Separate rinse		max. 5.0 kg
Extra option	Rinse hold	
Starch		max. 5.0 kg
Note	The laundry (table cloths, napkins, overalls) should be washed but not treated with fabric conditioner.	
Starching agent	Liquid starch, starch formulations, viscous liquid starch, starch	
Drain/Spin		max. 5.0 kg
Note	<p>For spinning fabrics. Please make sure you select the appropriate spin speed.</p> <p>Drain only: Select <i>Without spin</i>. Do not use for woollens.</p>	

WASHING

Programme sequence

	Main wash		Rinses		Spinning	
	Water level	Wash rhythm	Water level	Rinses	Spinning	Final spin
Cottons		Ⓐ		2-3 ²⁾	✓	✓
Minimum iron		Ⓐ		2-3 ³⁾	✓	✓
Delicates		Ⓑ		3	–	✓
Silks		Ⓓ		2	–	✓
Woolens		Ⓒ		2	✓	✓
Express		Ⓐ		2-3 ³⁾	✓	✓
Automatic		Ⓐ		2-3 ³⁾	✓	✓
Dark garments		Ⓐ		3	✓	✓
Shirts		Ⓐ		2	–	✓
Denim		Ⓐ		3	–	✓
Sportswear		Ⓐ		2	✓	✓
Outerwear		Ⓑ		3	✓ ⁴⁾	✓
Proofing	–	–		1	–	✓
Curtains ¹⁾		Ⓐ		3	–	✓
Separate rinse	–	–		2	–	✓
Starch	–	–		1	–	✓
Drain/Spin	–	–	–	–	–	✓

 = Low water level

 = Medium water level

 = High water level

Ⓐ = Normal wash rhythm

Ⓑ = Gentle action

Ⓒ = Woolens

Ⓓ = Silks

Please continue reading for further details about the programme sequences.

This washer-dryer has fully electronic controls with automatic load recognition. It takes in the right amount of water required for the programme depending on the amount of laundry and its absorbency rate. This means that programme cycles and durations can vary.

The programme sequences outlined in the chart are based on the basic programme with a full load. Extra options which can be selected have not been taken into account.

The display shows the stage the programme has reached.

Special features in the programme sequences:







Anti-crease:

At the end of every programme, with the exception of the *Woolens* programme, the drum continues to turn at intervals for up to 30 minutes to help prevent creasing. The door can be opened and laundry removed at any time during the anti-crease phase.



- 1) Pre-rinse: A Pre-rinse without detergent is carried out automatically to remove dust.
- 2) A third rinse is carried out if:
 - there is too much foam in the drum
 - a spin speed lower than 700 rpm has been selected
 - *Without spin* has been selected
- 3) A third rinse is carried out if:
 - Without spin* has been selected
- 4) In the *Outerwear* programme, laundry is only spun after the main wash.

WASHING





Garment care label symbols

	Hand wash (If no temperature is specified use the lowest temperature or cold)
	Do not wash
	Dry clean
	Do not dry clean
	Any oxidising bleaching agent can be used
	Only use an oxygen based bleach or a non-chlorine bleach
	Do not bleach

Tumble dry

	At normal temperature
	At low temperature
	Do not tumble dry

Ironing

	Hot iron
	Medium hot iron
	Cool iron
	Do not iron



Detergent

All modern detergents produced for automatic washing machines are suitable, including liquid, compact (concentrated), tablets and special application detergents. Use dispensing aids, e.g. balls, if these are supplied with the detergent. Tablets are suitable for full loads but note that it may be impractical to reduce tablets for smaller loads. Some tablets do not dissolve as rapidly as others and may not be suitable for programmes with short durations.

Silks, woollens and knitwear containing wool mixtures and hand-washable garments should be washed using a detergent specifically designed for washing silks and woollens. Do not use biological detergents on silk as the enzymes may damage the silk.

Instructions for use and recommended amounts for a full load are given on the detergent packaging.

Liquid detergent should be dispensed using a ball provided by the manufacturer for programmes without a pre-wash. Remember to take it out of the drum before running a drying programme!

For programmes with a pre-wash you will need to purchase a special container from the Miele Spare Parts department which sits in the main wash compartment  of the detergent dispenser drawer. Add liquid detergent to this container for the main wash and to compartment  for the pre-wash.

The right amount to dispense will depend on the following:

- The soiling level of the laundry
 - Lightly soiled
No visible dirt or stains.
 - Normally soiled
Visibly dirty and/or just a few slight stains.
 - Heavily soiled
Stains and soiling clearly visible.
- The water hardness level.
Check with your local water supplier if you do not know the hardness level in your area.
- The quantity of the laundry (add the recommended amount of detergent).

Water softeners

A water softener can be used to cut down on the use of detergents in hard water areas. Dispense according to the amount specified on the packaging. First add detergent and then the water softener.

Use a quantity of detergent as for soft water.

Miele do not recommend connecting the machine to a household water softener.

Washing with several components

If you wash using several components (e.g. special application detergents), we recommend always dispensing the agents into compartment  in the following order:

1. Detergent
2. Water softeners
3. Stain remover

This way the agents are distributed more evenly.

WASHING

Fabric conditioners or liquid starch

Fabric conditioners make garments soft to handle and help prevent static cling when tumble drying.

Starch stiffens and gives body to items of laundry, e.g. shirts, tablecloths and bed linen.

- Dispense according to the amount specified on the packaging.

Automatic dispensing of fabric conditioner or liquid starch to laundry at the end of a programme

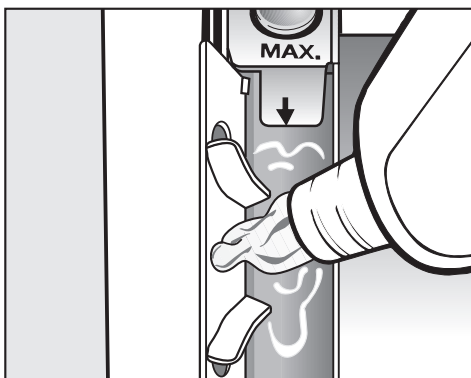

- Add the fabric conditioner or liquid starch to compartment ☼. **Do not exceed the maximum level mark.**

It will be automatically dispensed in the last rinse. At the end of the programme a small amount of water remains in the fabric conditioner compartment ☼.

If starching frequently, clean the dispenser compartment and especially the siphon tube and conditioner channel regularly. See "Cleaning the detergent dispenser drawer". Do not add starch

formulations or viscous liquid starch to the ☼ compartment as it will clog up.

Adding fabric conditioner separately

- Add fabric conditioner to compartment ☼.
- Turn the programme selector to *Further programmes* and select the *Starch* programme.
- Press the *Start/Stop* button.

Adding starch separately

- Prepare the starch solution in accordance with manufacturer's instructions on the packaging.
- Add the starch to compartment ☼.
- Turn the programme selector to *Further programmes* and select the *Starch* programme.
- Press the *Start/Stop* button.

Colour run and dye removers / dyes

- Do not use colour run or dye removers in this machine.
- Dyes suitable for use in domestic washing machines can be used. However, please note that the salt used in the dyeing process can cause corrosion to stainless steel components in the machine if you dye frequently. Always observe the manufacturer's instructions carefully.

Separate drying

The separate drying programme must be used if the load in the wash programme is greater than the maximum load permitted for drying, or if you only want to dry part of the load that was washed.

- Before drying check the drying symbol on the care label.
- ☉ Dry at normal temperature
- ☉ Dry at a low temperature (select the *Low temperature* extra option)
- ☒ Do not tumble dry

If there is no symbol, dry at your own risk applying the following principles:

- Cottons and minimum iron items should be dried using the appropriate programme.
- Delicate fabrics, e.g. acrylics, should be dried at a low temperature (select the *Low temperature* extra option).

Tips on drying

Do not put soaking wet items into the tumble dryer. Spin them thoroughly after washing using the appropriate spin speed.

- Woollens and wool blends tend to become matted and shrink if dried in a tumble dryer. They can be partially dried using the *Woollens* programme.

- Down-filled garments have linings which have a tendency to shrink, depending on the quality of the item. They can be partially dried using the *Smoothing* programme.
- Pure linen should only be machine dried if specified as suitable by the manufacturer on the care label, as the surface of the fabric may otherwise tend to roughen. They can be partially dried using the *Smoothing* programme.
- Loopknit garments (e.g. T-shirts and underwear) tend to shrink depending on their quality. Do not over-dry these textiles. When purchasing these garments it is advisable to take their shrinkage properties into account.
- Starched laundry can be dried in the tumble dryer. To achieve the usual finish, double the amount of starch should be used.
- Minimum iron fabrics and 100% cotton shirts or blouses tend to crease more, the larger the load. This is particularly the case with delicate fabrics. If in doubt, reduce the load or use the *Shirts* programme.
- New dark coloured garments should be washed and dried separately from light coloured garments to avoid the danger of colours running and discolouring other garments. Dark coloured fibres can also settle on light coloured garments and vice versa.

DRYING

1 Sort the laundry

- Sort the laundry according to type of fibre / weave and the residual moisture content. This will help achieve an even drying result.

2 Switch the machine on

The interior drum lighting will come on.

3 Select a programme

- Turn the selector to the drying programme you require.

The programme selected will appear in the display.

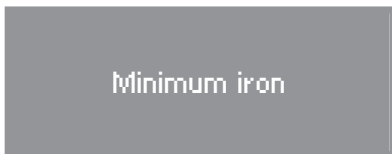

Further programmes:

When you turn the programme selector to *Further programmes*, a list of these programmes will appear in the display.

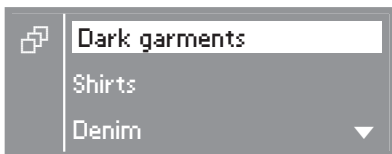

- Select the programme you want and confirm your selection with the **OK** button.
- Press the *Washing/Drying* button repeatedly until **only** the *Drying* indicator light is lit up.

The *Washing* indicator light must not be lit up as this would mean that the corresponding washing programme would begin before the drying process.



or

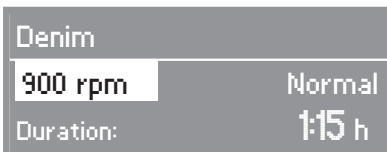

- You can then alter the thermospin speed which is shown highlighted with the - or + buttons. Press the **OK** button to confirm the thermospin speed you want. The display will then change to show the drying level.
- You can then alter the drying level which is shown highlighted with the - or + buttons.

The thermospin is not carried out with Smoothing or timed drying.

- Select the *Low temperature* extra option if required.

Exception: If the *Low temperature* extra option has been selected, the thermospin will **only** be carried out in the *Express* programme.

- Select Delay start, if required.

4 Load the drum

- Open the drum door.
- Load the laundry loosely into the drum.

Do not overload the drum. See the "Programme chart" in the "Drying" section for recommended loads for each programme. Overloading can cause unnecessary wear and tear to the laundry and give a disappointing drying result.

5 Close the drum door

Make sure you have removed any detergent dispensing aids, e.g. plastic dispenser balls, before drying. These dispensers can melt during the drying programme and cause damage to the machine and the laundry.

Make sure that no garments are caught between the drum door and seal.

The stopcock must be open even if you are only using the machine for drying.

6 Start the programme

- Press the flashing *Start/Stop* button.

The estimated programme duration will appear in the display. The electronics continually assess the residual moisture content of the laundry and adjust the estimated time remaining for a more accurate reading. Because of this the time displayed can alter during the course of a programme. The time remaining will count down in one minute steps. The programme sequence and

the drying level reached will also be shown in the display.

The drum lighting switches off once the programme has started.

7 Remove the laundry when the programme has finished

In the anti-crease phase after the programme has finished, the following will appear alternately in the display:

Anti-crease

and

i Programme finished.
Remove laundry, then
switch the machine off.

- Turn the programme selector to the *Stop* position.
- Open the drum door.
- Remove the laundry.

Check that all items have been removed from the drum. If items are left in the dryer, they could be damaged by overdrying when the dryer is next used.

Important: Always remove the laundry before switching the machine off. This is important to ensure that the load size indicator works correctly the next time the machine is used.

- Switch the machine off.

See "After each washing or drying programme" for further information.

DRYING

Extra option

Low temperature

The temperature is reduced during the drying programme.

For all delicate or minimum iron fabrics with the  symbol on the care label (e.g. acrylic garments).

With the exception of the *Express* programme, the thermospin is not carried out when the *Low temperature* extra option has been selected.

Because the temperature is reduced when the *Low temperature* extra option has been selected, the programme duration is longer.

The *Low temperature* extra only applies to drying.

Thermospin

To save energy a thermospin is carried out before the drying process begins in the *Cottons*, *Minimum iron*, *Express*, *Automatic*, *Dark garments*, *Shirts*, *Denim*, *Sportswear*, and *Outerwear* programmes.

Exception: If the *Low temperature* extra option has been selected, the thermospin will **only** be carried out in the *Express* programme.

Exception: Thermospin will not be carried out if *Timed drying* or *Smoothing* has been selected.

The maximum spin speed for the thermospin is the same as the maximum final spin speed for the relevant wash programme.

Adding or removing laundry after a programme has started

- Press the *Door* button to open the drum door.

 Do not touch the metal cap located on the inside of the door glass or the back of the drum when adding or removing items. They could be very hot - **Danger of burning.**

- Add or remove items as required.
- Close the drum door.

The programme will continue automatically.

The time left shown in the display may now vary from the actual drying time.

The door cannot be opened, if:

- the temperature is above 70°C (see "Settings menu - Door release").
- the programme has reached the *Thermospin* stage.
- the electronic programme locking has been activated.

Programme chart

Cottons		max. 2.5 kg*
Extra dry, Normal+, Normal**, Timed drying¹⁾		
Fabric type	Single and multi-layered cotton fabrics such as towelling, jerseywear, underwear, flannelette bed linen.	
Note	Do not use <i>Extra dry</i> for jersey fabrics as they have a tendency to shrink.	
Extra options	Low temperature, thermospin max. 1600 rpm	
Hand iron Δ, Hand iron ΔΔ, Machine iron, Timed drying¹⁾		
Fabric type	Cotton or linen fabrics (e.g. table linen, bed linen, starched laundry etc.).	
Note	To prevent laundry from drying out it should be rolled up until you are ready for ironing.	
Extra options	Low temperature, thermospin max. 1600 rpm	
Minimum iron		max. 1.25 kg*
Normal+, Normal**, Timed drying¹⁾		
Fabric type	Minimum iron items made of cotton, synthetic or blended fabrics, e.g. shirts, blouses, skirts and table cloths.	
Extra options	Low temperature, thermospin max. 1200 rpm	
Hand iron Δ, Timed drying¹⁾		
Fabric type	Minimum iron items made of cotton or blended cotton/synthetic fabrics, e.g. blouses, table cloths, for machine ironing.	
Extra options	Low temperature, thermospin max. 1200 rpm	

* Weight of dry laundry

** Note for test institutes: Use this programme when testing according to EN 50229 standard

DRYING

Delicates		max. 1.0 kg*
8 minutes		
Fabric type	For delicate fabrics made of synthetic fibres, mixed fibres, easy care cotton shirts and blouses.	
Note	This programme is for "loosening" up fabrics. They are not completely dried in this programme. Remove garments immediately at the end of the programme.	
Woollens		max. 1.0 kg*
3 minutes		
Fabric type	Woollen or wool blend fabrics.	
Note	This programme only fluffs up woollen garments. They are not dried completely by this programme. Remove garments immediately at the end of the programme.	
Express		max. 2.5 kg*
Extra dry, Normal+, Normal Hand iron Δ, Hand iron $\Delta\Delta$, Machine iron, Timed drying¹⁾		
Fabric type	Small loads of garments which can be dried in the Cottons programme.	
Extra options	Low temperature, thermospin max. 1600 rpm	
Automatic		max. 2.5 kg*
Normal+, Normal, Hand iron Δ, Timed drying¹⁾		
Fabric type	Mixed load of cotton and minimum iron fabrics.	
Extra options	Thermospin max. 1200 rpm	
Dark garments		max. 2.5 kg*
Normal+, Normal, Hand iron Δ, Timed drying¹⁾		
Item	Dark garments made from cotton or mixed fibres.	
Extra options	Low temperature, thermospin max. 1200 rpm	

* Weight of dry laundry

Shirts		max. 1.0 kg*
Normal+, Normal, Hand iron Δ, Timed drying¹⁾		
Garment	Shirts and blouses.	
Extra option	Thermospin max. 600 rpm	
Denim		max. 2.5 kg*
Extra dry, Normal+, Normal Hand iron Δ, Hand iron ΔΔ, Machine iron, Timed drying¹⁾		
Extra option	Thermospin max. 900 rpm	
Sportswear		max. 2.0 kg*
Normal+, Normal, Hand iron Δ, Timed drying¹⁾		
Garment	Sportswear which is suitable for drying in a tumble dryer.	
Extra option	Thermospin max. 1200 rpm	
Outerwear		max. 1.0 kg*
Normal+, Normal, Hand iron Δ, Timed drying¹⁾		
Garment	Outerwear which is suitable for drying in a tumble dryer.	
Extra option	Thermospin max. 800 rpm	
Proofing		max. 1.5 kg*
Normal		
Garment	For thermally fixing textiles which are suitable for drying in a tumble dryer and have been treated with a proofing agent.	

* Weight of dry laundry

¹⁾ **Timed drying:** The *Cottons, Minimum iron, Express, Automatic, Dark garments, Shirts, Denim, Sportswear* and *Outerwear* programmes can be dried using *warm air* timed drying for durations of between 15 minutes and 2 hours. The drying temperature is determined by the particular programme being used. To smooth out creasing, you can also use *Smoothing* (fabrics are not dried completely).

DRYING

Smoothing		max. 2.5 kg*
8 minutes		
Fabric type	Cotton and linen fabrics. Minimum iron items made of mixed fibres, cottons or synthetics, e.g. trousers, jackets, shirts.	
Note	Smooths out creasing caused during the spin cycle in the wash programme. Fabrics are not completely dried in this programme. Remove garments as soon as the programme has finished and leave to finish drying at room temperature.	
Timed drying - Warm air		max. 2.5 kg*
15 minutes to 2 hours		
Fabric type	For drying or airing individual items.	
Note	Do not select the longest drying time to start with. Check the items as you are drying them to find the optimum time.	
Timed drying - Cool air		max. 2.5 kg*
15 minutes to 2 hours		
Fabric type	Any item which only needs airing.	

* Weight of dry laundry

Washing and drying in a continuous sequence

Where the amount of laundry to be washed and dried in one programme does not exceed the maximum weight permitted for the drying programme, washing and drying in one continuous sequence is recommended.

It is very important to read both the "Washing" and "Drying" sections before proceeding.

1 Sort the laundry into colours and fabric types

2 Switch the machine on

3 Select a programme

- Turn the programme selector to the required programme.

Minimum iron

- Press the *Washing/Drying* button repeatedly until both the *Washing* and *Drying* buttons are lit up.

40°C 900 rpm
Normal
Duration: 1:26 h

- Select the temperature and spin speed you want and confirm with the **OK** button.

When washing and drying in a continuous sequence the laundry is spun at max. 1200 rpm at the end of the wash cycle to prevent it sticking to the drum.

- Select the drying level or drying time you require.

Denim
40°C 900 rpm ▶
Duration: 2:15 h

When you select *Further programmes* the arrow next to the spin speed in the display indicates that you can call up the drying level designated for the programme.

- Now select extra options, if required.

Thermospin will be carried out at the same speed as the spin speed displayed for the washing programme.

Exception: If the *Low temperature* extra option has been selected, the thermospin will **only** be carried out in the *Express* programme.

- Select Delay start, if required.

WASHING AND DRYING

4 Load the drum

- Open the drum door and load the laundry loosely in the drum.

Follow the load size indicator and do not overload.

Do not use detergent dispensing aids, e.g. plastic dispenser balls, for washing followed immediately by the drying programme. These dispensers can melt during the drying programme and cause damage to the machine and the laundry.

5 Close the drum door

6 Add detergent

Follow the detergent percentage display.

7 Start the programme

- Press the *Start/Stop* button.

8 Remove the laundry when the programme has finished

- Turn the programme selector to the *Stop* position.
- Open the drum door and remove the laundry.

See "After each washing or drying programme" for further information.

After each washing or drying programme

- Open the drum door **fully**.

 **Warning, the metal cap located on the inside of the door glass is very hot after drying.** Do not touch it. Danger of burning!

- Remove the laundry.

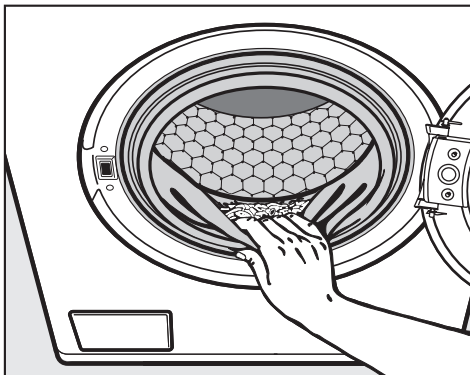

- Check the folds in the door seal for any small articles, e.g. buttons which might be lodged there. Remove any fluff from drying from around the door seal.

Check that all items have been removed from the drum. Items left behind could colour run, shrink or be damaged in the next washing or drying programme.

Important: Always remove the laundry before switching the machine off. This is important to ensure that the load size indicator works correctly the next time the machine is used.

- Switch the machine off with the *I-On/0-Off* button.

- Close the door. Otherwise there is the danger of objects being placed inadvertently in the drum. If these remained unnoticed and were washed or dried in the next load, they could damage the laundry.

After drying

Rinse out fluff programme

The fluff which occurs during drying can collect in the drum and also in the suds container. It is best to rinse out this fluff before the machine is used again so that it cannot be deposited on the next load (e.g. fluff from dark garments being deposited on lighter coloured items) or cause a blockage.

The *Rinse out fluff* programme must not be used for rinsing laundry. Make sure that there is no laundry in the drum before starting this programme.

- Switch the machine on.
- Turn the programme selector to the *Rinse out fluff* programme.
- Press the *Start/Stop* button.

The fluff will be rinsed out after a few minutes.

- Remove any remaining fluff from around the door seal.
- Switch the machine off.

The load size sensor must be recalibrated to zero after running the *Rinse out fluff* programme. See "Before using for the first time" for instructions on how to do so.

Changing the programme sequence

Cancelling a programme

You can cancel a programme at any time after it has started.

- Press the *Start/Stop* button briefly or turn the programme selector to *Stop*.

... During washing:

The suds will be pumped away and the washing programme is cancelled.

... During drying:

The garments will be cooled down before the door can be opened.

If you want to remove the laundry:

- Press the *Door* button.

If you want to select a different programme:

- Switch the machine off with the *I-On/O-Off* button.
- Switch the machine back on again and select a new programme.

Interrupting a programme

- Switch the machine off with the *I-On/O-Off* button.

To continue with the same programme:

- Switch the machine on with the *I-On/O-Off* button.

 Do not switch the washer-dryer off before the end of a drying programme. If this was done and the laundry was then removed immediately, it could give off a great deal of heat.

Altering a programme

After the start of a programme it is no longer possible to select a different programme.

You will need to cancel the current programme before you can select a new one.

Altering the temperature

You can alter the temperature of a washing programme up to 5 minutes after the programme has started.

- Use the **-** and **+** buttons to alter the temperature.

Changing the programme sequence

Altering the spin speed

- Press the **OK** button. The spin speed will be shown highlighted. You can use the **-** and **+** buttons to change the spin speed up until the final spin begins.

You can change the thermospin speed up until the thermospin begins.

Altering the drying level / drying time

You can alter the drying level or drying time during the washing programme but not once the drying programme has started.

Selecting or deselecting a drying programme

You can select or deselect the drying function during a washing programme if this is permitted for the particular programme.

Changing extra options

It is possible to select or deselect the *Short* and *Water plus* extra options up to 5 minutes after the washing programme has started.

The buzzer can be switched on or off at any time.

Please note that no changes are possible if programme locking has been activated.

Electronic programme locking

Programme locking prevents the machine from being opened or the programme cancelled during a washing or drying programme.

To activate programme locking

- Once the programme has started, press the *Start/Stop* button for at least 6 seconds until the following appears in the display:



The machine will now not accept any changes and the programme will proceed through to the end.

Programme locking is deactivated automatically at the end of the programme.

Deactivating programme locking early

- Press the *Start/Stop* button for at least 6 seconds until the following appears in the display:

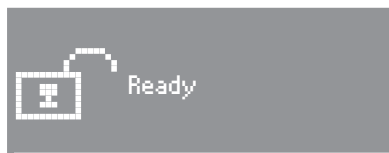

Delay start

With delay start you can choose when you want the programme to end. The start of a programme can be delayed from 30 minutes up to a maximum of 24 hours, allowing you to make use of night-time economy electricity rates, for example.

The current time of day needs to have been set for delay start to work correctly.

To select Delay start

- Select the programme you want and then press the ⊖ button.

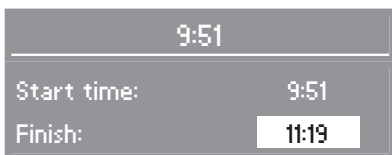

The display shows the current time of day and the time the programme is due to end.

- Use the + button to select the time you want the programme to end at.

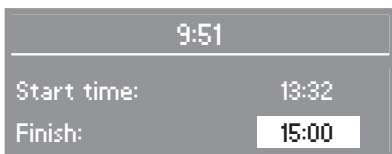

The first press on the button will adjust the programme end time to the next full or half hour. Each subsequent press on the button will delay the programme end time by 30 minutes.

Use the - button to shorten the time if you have chosen too long a time.

- Confirm the programme end time by pressing the **OK** button.

To begin Delay start

- Press the *Start/Stop* button.



The display will show when the programme will be started in hours and minutes.

To alter Delay start

- Press the ⊕ button.
- Use the + and – buttons to alter the time you want the programme to end at.
- Press the **OK** button to confirm the time selected.

To cancel Delay start

- Press the ⊖ button.
- Use the – button to bring the end time of the programme forward until it is the same as the current time of day.
- Press the **OK** button to confirm.

The programme will now start immediately.

The actual load size can only be determined accurately by the machine once the programme has started. The programme end time may, therefore, be a bit later or earlier than first indicated.

 Disconnect the machine from the electricity supply by switching off at the wall socket and withdrawing the plug before any cleaning and maintenance work.

Cleaning the machine

 Do not use solvents, abrasive cleaners, glass cleaners or all-purpose cleaning agents. These might damage plastic surfaces and other components because of the chemicals they contain.

 The machine must not be hosed down.

- Clean the casing with a mild non-abrasive cleaning agent or soap and water. Wipe dry with a soft cloth.
- The drum can be cleaned using a suitable proprietary stainless-steel cleaning agent following the manufacturer's instructions on the packaging.

E-Cloth

A microfibre "E-Cloth" is available from the Miele UK Spare Parts Department, or via the internet (depending on country), which is suitable for cleaning surfaces such as stainless steel, glass, plastic and chrome without the use of chemicals.

Extra cleaning

Carry out a hot wash (70°C or above) with powder detergent approx. every 6 weeks to help prevent deposits building up in the machine. These can occur when washing is mainly done at low temperatures, and also lead to unpleasant smells. If you have no reason to wash occasionally at this high temperature, then run a Cottons 95°C programme with detergent but no laundry at regular intervals.

Cleaning the detergent dispenser drawer

Remove detergent residues regularly.

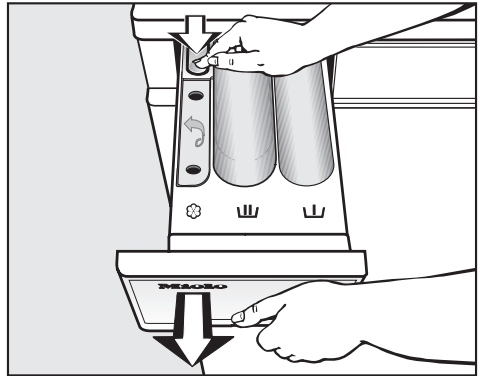

- Pull out the detergent dispenser drawer until a resistance is felt. Press down the release catch and at the same time pull the drawer right out of the machine.
- Clean the detergent drawer with warm water.

Cleaning and care

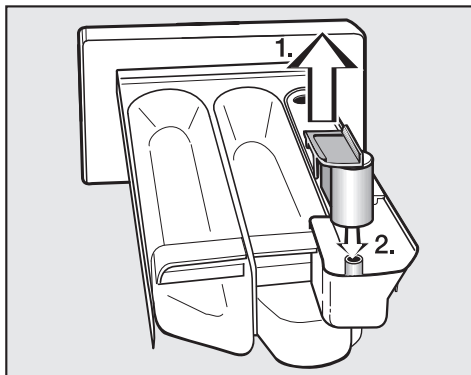

■ Clean the siphon.

1. Remove the siphon from compartment  and rinse under warm running water. Clean the siphon tube in the same way.
2. Replace the siphon.

If starching frequently, thoroughly clean the siphon and siphon tube regularly. A build-up of starch will cause them to get clogged.

Cleaning the detergent dispenser drawer housing

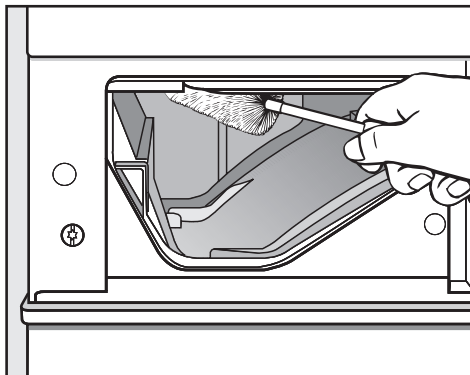

- Use a bottle brush to remove detergent residues and limescale from the jets inside the detergent dispenser drawer housing.

Descaling the machine

If the correct amount of detergent is dispensed, the machine should not need to be descaled. If, however, you do wish to descale the machine, only use proprietary non-corrosive descaling agents and strictly observe the instructions on the packaging. A special descaling agent is available to order from the Miele Spare Parts Department or via the internet (depending on country).

Cleaning the porthole glass

- From time to time you should also clean ...
 - the door glass on the inside using a mild detergent or soap and water.
 - the metal cap on the inside of the door glass with a suitable proprietary stainless steel cleaning agent following the manufacturer's instructions on the packaging.
- Wipe dry using a soft cloth.

Cleaning the filter in the water inlet

The machine has a filter to protect the water inlet valve.

The accessible filter in the union in the open end of the inlet hose should be checked every six months, or more often if there are frequent interruptions to the external water supply.

- First turn off the stopcock.
- Unscrew the threaded union connecting the free end of the inlet hose to the stopcock.

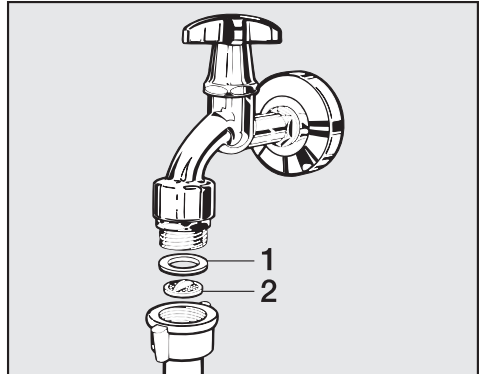

- Remove the rubber seal **1** from the recess.
- Using pointed pliers, take hold of the plastic filter bar **2** and remove.
- Clean the plastic filter.
- Put the filter and seal back in the reverse order and reconnect the hose.

Turn on the stopcock and check the connection is watertight. If water drips out, tighten the connection.

Never forget to put the filter back in place after cleaning.

Problem solving guide





What to do, if . . .

With the help of the following notes, minor faults in the performance of the appliance, some of which may result from incorrect operation, can be put right without contacting the Service Department.

 Repair work to electrical appliances should only be carried out by a suitably qualified person in accordance with local and national safety regulations. Repairs and other work by unqualified persons could be dangerous. The manufacturer cannot be held liable for unauthorised work.

The programme does not start.

Problem	Possible cause	Remedy
The display remains dark and the programme selector is not lit up.	There is no power to the machine.	Check whether <ul style="list-style-type: none">– the mains plug is plugged in and switched on.– the fuse or circuit breaker has tripped.
The display shows: Machine locked Enter code.	The electronic system lock has been activated (see <i>Settings menu</i>  /Lock).	Enter the code for the system lock and confirm the entry. Deactivate the system lock if you do not wish this message to appear in the display the next time the machine is switched on.
The programme does not start when <i>Drain/Spin has been selected.</i>	The machine has not been prepared for using for the first time.	Prepare the machine as described in "Before using for the first time".
The display is dark.	The display has switched off automatically to save energy (Standby mode).	Press a button. Standby comes to an end.



Fault messages in the display		
Message in the display	Possible cause	Remedy ❶
 Drain fault	<ul style="list-style-type: none"> – The water outlet is blocked or restricted. – The drain hose has been fixed too high. 	<ul style="list-style-type: none"> – Clean the drain filter and the drain pump as described in "Opening the drum door in the event of a blocked drain outlet and/or power failure". – The maximum drain height is 1 m.
 Inlet fault	<ul style="list-style-type: none"> – The water inlet is blocked or restricted. 	Check whether <ul style="list-style-type: none"> – the stopcock is opened wide enough. – the inlet hose is kinked.
 WPS activated	The water protection system has reacted.	Call the Service Department.
 Drum lighting fault	The drum lighting unit is not fitted correctly.	Fit it correctly.
 Technical fault Call the Service Department	There is a fault.	Start the programme again. If the fault message appears again, contact the Service Department.

❶ To switch off the fault message: Switch the machine off with the *I-On/O-Off* button.

Problem solving guide



Problems with the load size indicator		
Problem	Possible cause	Remedy
The display indicates a load of <25% or no load size is indicated when the drum is full.	There was laundry in the drum when the machine was switched on. This has decalibrated the sensor from the zero setting.	To recalibrate the sensor to the zero setting: <ul style="list-style-type: none"> – Remove the laundry from the drum. – Switch off the machine and leave the door open. – Switch on the machine. – Turn the programme selector to the <i>Cottons</i> position. Press and hold the <i>Load/Detergent</i> button pressed in until the following appears in the display: <i>Zero setting OK.</i>
The display indicates a load greater than <25% when the drum is empty.	The load size sensor has been decalibrated from the zero setting.	Rotate the drum once. If the display still indicates a load greater than <25%, recalibrate the sensor to zero again (see above section).
The following fault message appears in the display: Zero setting not possible	The drum door is closed.	<ul style="list-style-type: none"> – Open the drum door. – Recalibrate the sensor to zero again.
The drying programme stops and the following message appears in the display: Check load	There is very little or no laundry in the drum. Drying individual garments or items which are already dry can also cause the programme to be cancelled.	In future, use timed drying after selecting a specific drying programme or use the <i>Warm air</i> timed drying programme for drying individual items.
At the end of a drying programme the following message appears in the display: Check load	The machine has recognised an overload.	In future do not exceed the maximum load.

Problem solving guide



General problems		
Problem	Possible cause	Remedy
The machine shakes during the spin cycle.	The machine feet are not level.	Level the machine (see "Installation and connection").
The pump makes strange noises.	This is not a fault! These noises occur at the end of a pump sequence as a normal part of the operation.	
Large amounts of detergent residue remain in the detergent dispenser drawer.	The water supply pressure is too low.	<ul style="list-style-type: none"> – Clean the filter in the water inlet. – It may be useful to select the <i>Water plus</i> extra option.
	Powder detergent used in conjunction with water softeners tends to become sticky.	In future, add washing powder into the dispenser drawer first, and then add the water softener.
Fabric conditioner is not completely dispensed or too much water remains in the  compartment.	The siphon tube is not correctly positioned or is clogged up.	Clean the siphon, (see "Cleaning and care - Cleaning the detergent dispenser drawer").
The laundry has not been spun satisfactorily.	The spin speed selected was too low.	Select a higher spin speed next time.
When laundry is dry it feels hard to the touch.	Too vigorous wash action.	Programme in gentle action and more water.
	Not enough detergent was used.	Increase detergent dose to prevent limescal build up in laundry.
	No fabric conditioner was used.	Use fabric conditioner in last rinse.
The display is in a different language.	A different language has been selected in "Settings  "Language  .	Set the language you want. The flag symbol will guide you.

Problem solving guide

An unsatisfactory wash result		
Problem	Possible cause	Remedy
Liquid detergent does not give the required result.	Liquid detergents usually contain no bleaching agents. They do not remove fruit, coffee and tea stains.	<ul style="list-style-type: none"> – Use a general purpose detergent containing a bleaching agent. – Pour stain removers into compartment  and liquid detergent into a dispenser ball (remember to remove the dispensing ball before drying!). – Never put stain removers and liquid detergent together in the dispenser drawer.
Grey, greasy particles cling to washed laundry.	Insufficient detergent has been used to break down the particles of grease in heavily soiled laundry.	<ul style="list-style-type: none"> – Use more detergent. – Before washing the next load run a <i>Cottons 95°C</i> programme with powder detergent but without a load.
White residues which look like powder detergent are seen on dark textiles after washing.	The detergent contained compounds (zeolites) to aid water softening which are not soluble in water. They have ended up on the laundry.	<ul style="list-style-type: none"> – Try and brush off the residues with a soft brush once the laundry is dry. – Wash dark textiles using a detergent which contains no zeolites. Liquid detergents usually contain no zeolites.
A stale smell is in the drum and on laundry.	Low temperature washing.	Before washing the next load run a <i>Cottons 95°C</i> programme with powder detergent but without a load.
Clothes are coming out creased.	Programme was overloaded.	Reduce quantity of clothes in the drum.
	The wrong programme was used.	<ul style="list-style-type: none"> – Check care labels and the programme chart. – Use easy iron conditioners.

An unsatisfactory drying result		
Problem	Possible cause	Remedy
The laundry is still damp after a drying cycle.	The load was too small for the electronics to assess the residual moisture correctly.	In future dry small loads in a timed drying programme.
	The laundry has formed a ring in the drum during the spin because it was distributed unevenly.	<ul style="list-style-type: none"> – Turn the programme selector to <i>Stop</i>. – Open the door and loosen the laundry.
	The laundry has formed a ring in the drum during the thermospin because it was too damp or the spin speed was set too high.	<ul style="list-style-type: none"> – Start the drying programme again using a lower spin speed.
	Warm laundry feels damp.	Extend the cool down time, as described in "Settings menu  ", "Set extended cool-down".
The laundry is too damp or too dry after a drying cycle.	The required residual moisture level is between two drying levels.	Either extend or shorten the drying times, as described in "Settings menu  ", "Alter time".
There is still water in the drum after drying.	There is a blockage in the water outlet.	Clean the drain filter and the drain pump as described in "Problem solving guide – Opening the drum door in the event of a blocked drain outlet and/or power failure".

Problem solving guide

The drum door cannot be opened by pressing the <i>Door</i> button	
Problem	Remedy
The machine is not connected to the electricity supply and / or is not switched on.	Insert the plug in the socket and switch on and / or switch the machine on with the <i>I-On/O-Off</i> button.
The electronic programme locking has been activated.	Deactivate programme locking as described in "Electronic programme locking".
The electronic system lock has been activated.	Deactivate the system lock as described in "Settings menu  ".
Power cut.	Open the drum door as described in the next section.
The door was not correctly engaged.	Press hard against the lock side of the drum door and then press the <i>Door</i> button.
There is still water in the drum and the machine is unable to drain.	Clean the drain filter and drain pump as described in the next section.
The door cannot be opened during or after a drying programme.	For safety reasons the drum door cannot be opened if the temperature higher than 70°C. <ul style="list-style-type: none"> – Wait until the temperature is below 70°C. – If the Door release setting has been deactivated, the door can only be opened if the temperature is below 55°C. Activate the Door release setting, as described in "Settings menu ". – Use the "Set extended cool-down" setting, as described in "Settings menu ".
For safety reasons the drum door cannot be opened if the suds temperature is higher than 55°C.	

Opening the drum door in the event of a blocked drain outlet and/or power failure

- Switch the machine off.

There is a lever behind the detergent drawer fascia panel.

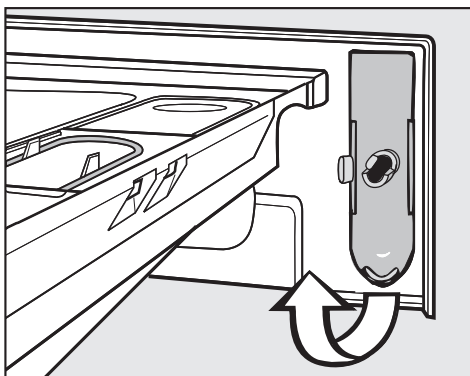

- Remove the lever.

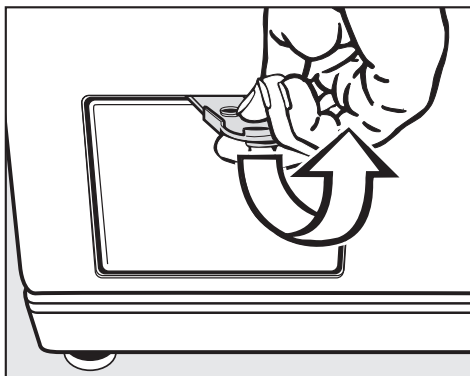

- Use it to open the access flap.

Blocked drain outlet

If the drain outlet is blocked, up to 25 litres of water will be retained in the machine.

⚠ Caution: if laundry has been washed at a high temperature, water draining out of the machine will still be hot. Danger of scalding!

Procedure for draining the machine

- Place a suitable container under the access flap.

When draining water from the machine, do **not** unscrew the drain filter completely or take it right out.



- Unscrew the drain filter lid until water runs out.

To interrupt the flow of water:

- Tighten the drain filter back up again.

Problem solving guide

Once the flow of water ceases:

- Remove the drain filter completely.

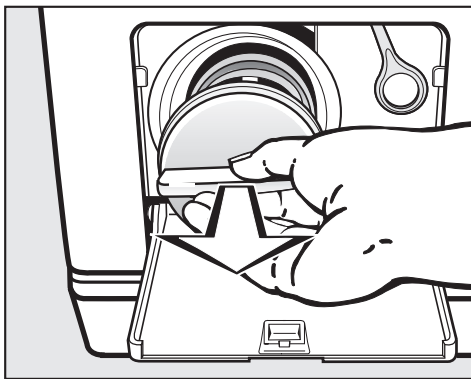

- Clean it thoroughly.

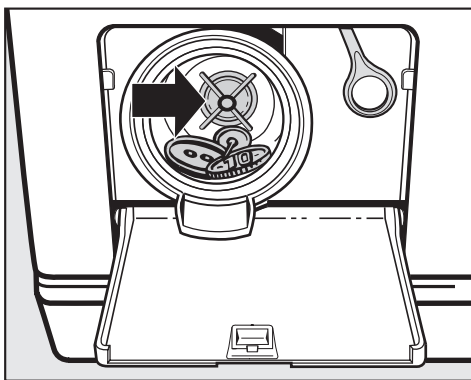

- Remove any foreign objects (e.g. buttons, coins, etc.) and fluff from the filter housing. Turn the impeller by hand to check that it rotates freely.
- Put the drain filter back in place and secure.

 Make sure the drain filter is securely tightened. Otherwise there is a risk of water leakage during use.

Opening the drum door

 Always make sure that the drum is stationary before reaching into the machine to remove laundry. Reaching into a moving drum is extremely dangerous.

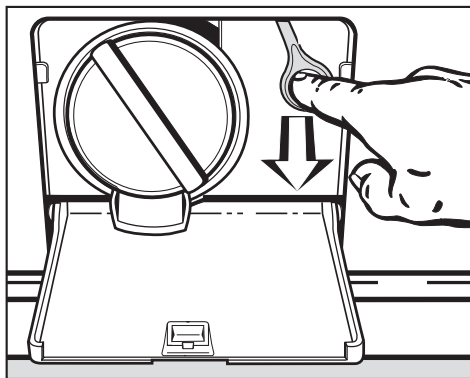

- Pull the emergency release downwards (see illustration). The drum door will open.

Changing the lamp for the drum lighting

The machine will still operate with no lamp in place or if the lighting is faulty.

- Remove the yellow lever from behind the detergent drawer facia panel.
- Switch the machine on and open the drum door.
- Now disconnect the machine from the electricity supply, see "Warning and Safety instructions".

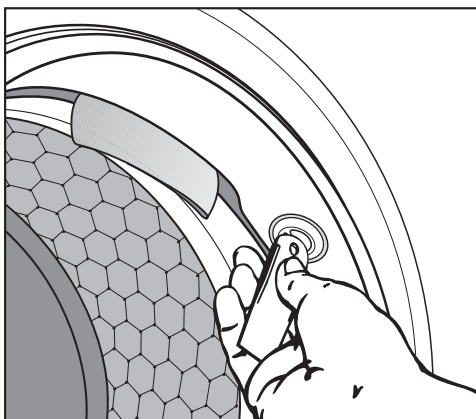

- Insert the lever in the slot provided in the drum lighting unit (see illustration) and turn anti-clockwise (a quarter turn) until you feel a resistance.
- Carefully pull out the loosened unit, using the lever to help you.

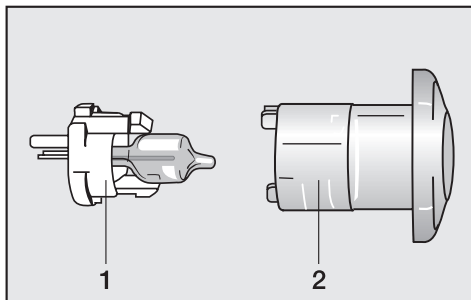

- Press the two prongs to separate the plastic holder **1** from the protective cover **2**.
- Remove the faulty lamp from the plastic holder.

The new lamp must be of the same type (G4) with a maximum power output of 5 watts/12 volts.

The lamps are available from an electrical retailer, your Miele Dealer or from the Miele Spare Parts Department.

- Insert the new lamp in the plastic holder.
- Carefully fit the plastic holder and the protective cover together.
- Insert the lighting unit into the socket and turn it clockwise to secure it.

It is absolutely essential for the correct functioning of the machine that the lighting unit is fitted correctly in position.

After sales service

In the event of any faults which you cannot remedy yourself, please contact:

- your Miele dealer, or
- the Miele Service Department (see back cover for contact details).

When contacting the Service Department, please quote the model and serial number of your appliance, both of which are shown on the data plate visible above the door glass when the door is open.

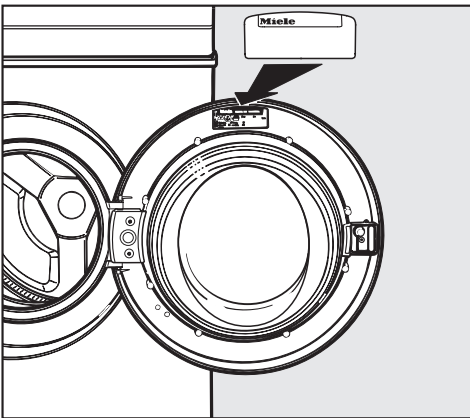

N.B. A call-out charge will be applied for unnecessary service visits where the problem could have been rectified by the customer as described in this installation manual.

Future updates (PC)

The indicator or check light marked PC is the interface used by Miele service technicians during servicing work for testing purposes and for updating the machine's programme data.

Appliance guarantee

Please see the guarantee card supplied with your machine.

Optional accessories

Optional accessories for this machine are available from your Miele Dealer or from the Miele Spare Parts Department.

Please note that telephone calls may be monitored and recorded for training purposes.

Installation and connection

Front view

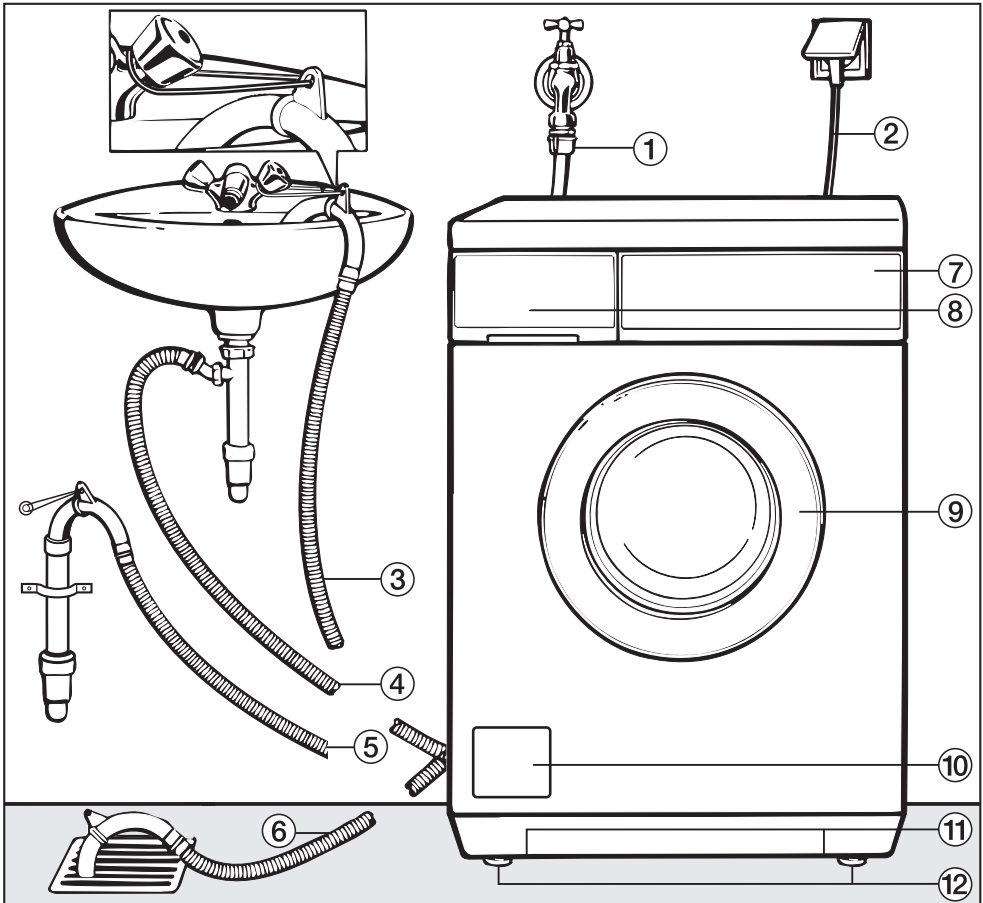

- ① Inlet hose
- ② Electricity supply cable
- ③ - ⑥ Flexible drain hose (with detachable swivel elbow)
- ⑦ Control panel
- ⑧ Detergent dispenser drawer
- ⑨ Drum door
- ⑩ Access to drain filter, drain pump and emergency release
- ⑪ Handle recesses for moving the machine
- ⑫ Four height adjustable feet

Installation and connection

Rear view

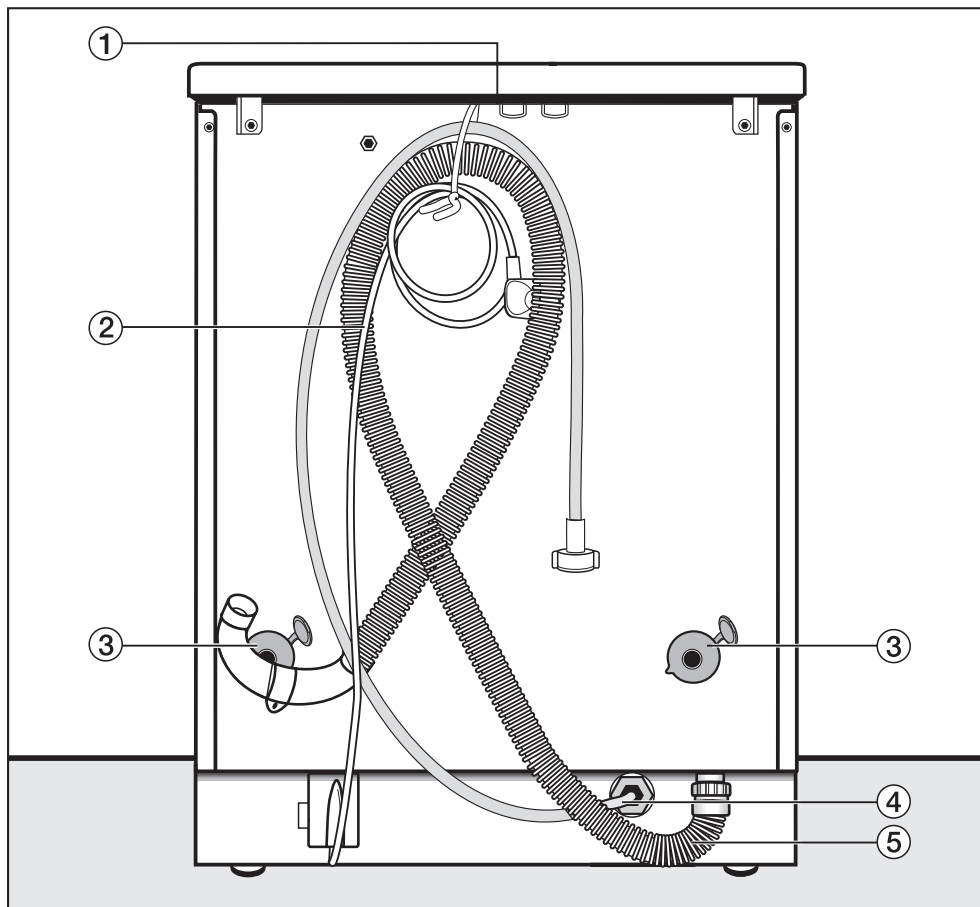

① Protruding lid for holding when moving the machine

② Electricity supply cable

③ Transit bar covers

④ Inlet hose

⑤ Drain hose

Installation surface

A concrete floor is the most suitable installation surface, being far less prone to vibration during the spin cycle than wooden floorboards or a carpeted surface.

Please note the following points:

- The machine must be level and securely positioned.
- To avoid vibrations during spinning, the machine should not be installed on soft floor coverings.

If installing on a wooden joist floor:

- We recommend a plywood base (at least 59x52x3 cm) The base should span several joists and be bolted to the joists and not only to the floorboards. Check for the presence of pipes and cables first.

If possible, install the machine in a corner, as this is usually the most stable part of the floor.

⚠ If the machine is installed on a raised plinth, it **has to be secured** against slippage during spinning using retaining clips (available from the Miele Spare Parts Dept).

Installing the washer-dryer

To manoeuvre the machine out of its packing case to its installation site, hold it by the edge of the lid where it protrudes to the rear of the machine as well as by the handle recesses at the front.

⚠ Ensure that the machine feet and the floor are dry to prevent the machine from slipping during the spin cycle.

Removing the transit fittings

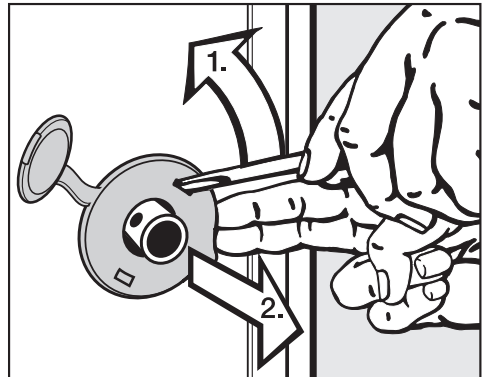

- To remove the left and right covers

1. Use a screwdriver to prise out the cover as illustrated.
2. Pull the cover forwards to remove.

Installation and connection

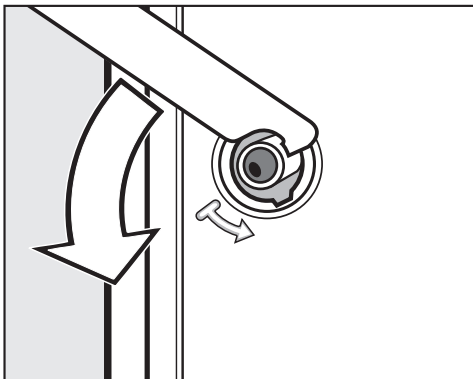

- Using the spanner supplied turn the left-hand transit bar 90°, then

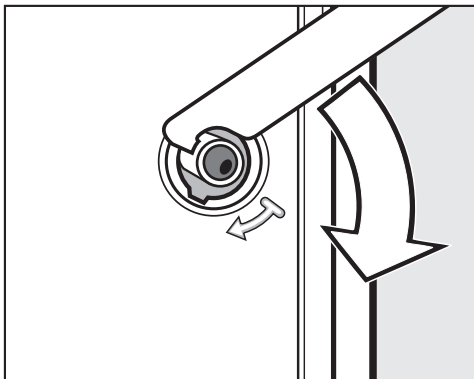

- Turn the right-hand transit bar 90°, then

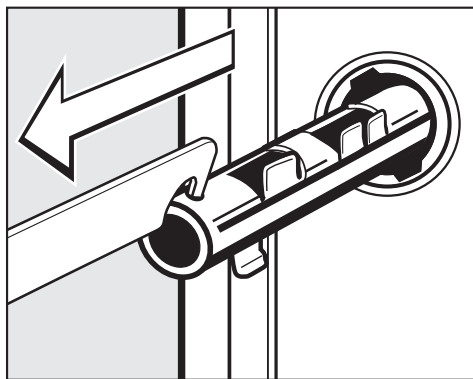

- withdraw the transit bar.

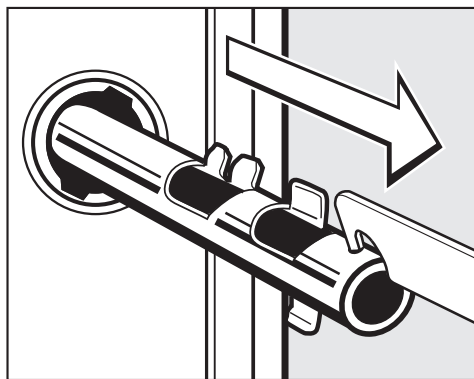

- withdraw the transit bar.

 To avoid the risk of injury the holes for the transit bars must be covered after the transit bars have been removed.

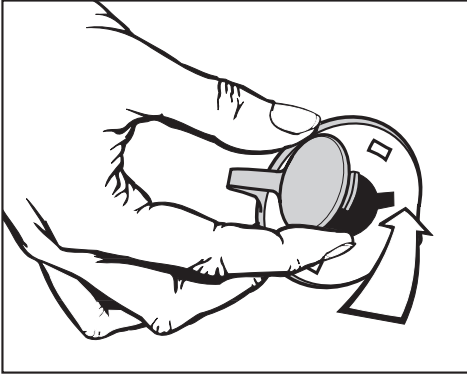

- Fit the covers on to the two holes. Then plug the holes as shown with the caps.

 The machine must not be moved without the transit fittings in place. Store them in a safe place for future use. They must be re-fitted if the machine is to be moved again (e.g. when moving house).

Re-fitting the transit bars

Re-fitting is carried out by reversing the procedure.

Levelling the machine

The machine must stand perfectly level on all four feet to ensure safe and proper operation.

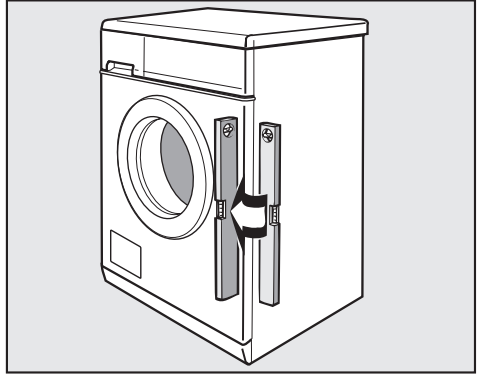

Incorrect installation may increase electricity and water consumption and may cause the machine to move about. False values may also show in the Load and Detergent display.

Installation and connection

Screwing out and adjusting the feet

The four adjustable screw feet are used to level the machine. All four feet are screwed in when the machine is delivered.

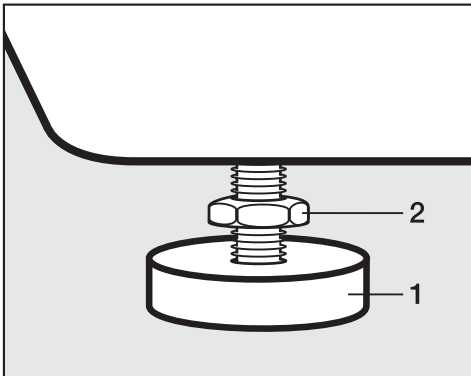

- Using the spanner supplied turn counter nut **2** in a clockwise direction. Then turn counter nut **2** together with foot **1** to unscrew.
- Use a spirit level to check the machine is standing level.
- Hold foot **1** securely with a pipe wrench. Turn counter nut **2** again using the spanner supplied until it sits firmly up against the housing.

 All four counternuts must sit firmly up against the housing. Please also check this for the feet which did not need adjustment. Otherwise there is the danger of the machine moving about.

Building under a continuous worktop / in a kitchen run

The fitting of building under kits must only be undertaken by qualified and competent persons, in accordance with the instructions supplied with the kit.

If you wish to push your machine under a worktop and there is space to do this **without removing the lid**, the conversion kit is not necessary. Otherwise it is essential.

- The building under conversion kit* includes a cover plate which must be fitted to ensure electrical safety.
- When installing under a 900/910 mm high worktop a raising kit* is required.
- Connections for electricity, water and drainage should be installed in such a way that they remain accessible when the machine is in place.

Fitting instructions are supplied with the conversion kit.

All parts marked * are available from the Miele Spare Parts Department.

The Miele water protection system

The Miele water protection system protects the machine from water damage.

The system consists of three main components:

- 1) the inlet hose
- 2) the electronic unit and the machine housing
- 3) the drain hose

1) Inlet hose

The inlet hose can withstand pressure of more than 7,000 kPa.

2) Electronic unit and machine housing

- Sump

Any leaking water is collected in a sump in the base of the machine. A float switches off the safety valves, preventing any more water flowing into the machine and water in the suds container is pumped away.

- Overflow protection

This prevents the machine taking in too much water. If the water level exceeds a certain level, the drain pump switches in and pumps the excess water away.

3) Drain hose

The drain hose is protected by a ventilation system which prevents the machine from being emptied completely.

Installation and connection

Connection to the water supply

The machine should be connected to a mains water supply in accordance with local and national safety regulations. The German authorities do not require it to have a non-return valve as the machine has been designed to comply with DIN regulations.

The machine is designed to operate with a flow pressure of between 100 kPa and 1,000 kPa. If it is higher than 1,000 kPa it is essential to fit a reducer valve.

Connection to the mains water supply should incorporate a mains stopcock with $\frac{3}{4}$ " thread. The stopcock should be fitted by a qualified plumber.

In order to protect the water inlet valve, the two dirt filters - one in the open end of the inlet hose, one at the inlet point in the machine must not be removed.

Extension hose

Longer hoses 2.5 or 4.0 m in length are available from your Miele dealer or the Miele Spare Parts Department as optional extras.

 The connection point is subject to mains water pressure. Turn on the stopcock slowly and check for leaks. Correct the position of the washer and union if appropriate.

The machine is **not** suitable for connection to a hot water supply and connection to a household water softener is not recommended.

Maintenance and care

Only use a genuine Miele hose should you ever need a replacement or extension. These are tested to withstand pressure of at least 7,000 kPa.

Connection to the drainage system

The machine drains via a drain pump with a delivery head of 1 metre. The drain hose must not be kinked as this restricts drainage. The swivel elbow at the end of the hose can be turned in either direction, or can be detached if required, with a sharp twist and pull.

If required the drain hose can be extended to a length of 5 m. The necessary parts can be purchased from the Miele Spare Parts Department or your Miele dealer.

Drain hose connection:

1. Direct into a sink or basin.

Please note the following:

- Hook the hose over the edge and secure.
 - Make sure that the water can drain away freely without hindrance. Otherwise there is a risk of water overflowing or of some of the drained water being sucked back into the machine.
2. Connected securely to a plastic drain pipe with a rubber nipple. There is no need to use a non-return valve.
 3. Connected securely to a standpipe.
 4. Connected securely to a floor gully.

Installation and connection

Electrical connection U.K.

All electrical work should be carried out by a suitably qualified and competent person, in strict accordance with national and local safety regulations.

Ensure power is not supplied to the appliance until after installation work has been carried out.

The appliance is supplied with a mains cable with moulded plug ready for connection to a 230-240V mains supply.

The voltage and connected load are given on the data plate. Please ensure these match the household mains supply. The fuse rating is quoted on the plug.

Connection should be made via a suitable switched socket which is easily accessible after installation.

For extra safety it is advisable to install a residual current device (RCD), with a trip current of 30 mA (in accordance with DIN VDE 0664, VDE 0100 Section 739).

Do not connect via an extension lead. Extension leads do not guarantee the required safety of the appliance (e.g. danger of overheating).



Non-rewireable plugs BS 1363

The fuse cover must be refitted when changing the fuse, and if the fuse cover is lost, the plug must not be used until a suitable replacement is obtained. The colour of the correct replacement cover is that of the coloured insert in the base of the plug, or the colour that is embossed in words on the base of the plug (as applicable to the design of plug fitted).

Replacement fuses should be ASTA approved to BS 1362 and have the correct rating. Replacement fuses and fuse covers may be purchased from your local electrical supplier.

**WARNING: THIS APPLIANCE
MUST BE EARTHED**

Consumption data

	Load	Consumption data				
		Energy in kWh	Water in litres	Duration		
				Short	Normal	
Washing						
Cottons	95°C	5.0 kg	1.70	42	1 h 53 min	2 h 08 min
	60°C ¹⁾	5.0 kg	0.85	42	1 h 29 min	1 h 58 min
	40°C ¹⁾	5.0 kg	0.49	42	1 h 29 min	1 h 58 min
Minimum iron	40°C ¹⁾	2.5 kg	0.44	49	1 h 05 min	1 h 20 min
Delicates	30°C	1.0 kg	0.33	65	49 min	59 min
Automatic	40°C	2.5 kg	0.30 - 0.60	30 - 50	1 h 00 min	1 h 15 min
Express	40°C	2.5 kg	0.30	30	-	32 min
Woolens 	30°C	2.0 kg	0.22	35	-	39 min
Silks 	30°C	1.0 kg	0.24	39	-	36 min
Drying						
Cottons	Normal ²⁾	2.5 kg	1.30	11	-	1 h 12 min
Minimum iron	Normal ²⁾	1.25 kg	0.65	5	-	37 min
Washing and Drying in a continuous sequence						
Cottons	60°C Normal ³⁾	5.0 kg	3.40	65	-	4 h 30 min
Cottons	60°C Normal	2.5 kg	2.30	45	-	3 h 00 min

Note for test institutes:

- 1) EN 60456 test programme
- 2) EN 61121 test programme
- 3) EN 50229 test programme

Consumption data can vary from the nominal values given depending on water pressure, water hardness, water inlet temperature, room temperature, type and volume of load, fluctuations in the electricity supply and any extra options selected.

Technical data

Height	850 mm
Width	595 mm
Depth	580 mm
Depth with door open	975 mm
Height for building under	820 mm
Width for building under	600 mm
Depth for building under	600 mm
Weight	101 kg
Maximum floor load	1600 Newton (approx. 160 kg)
Capacity - Washing	5.0 kg dry laundry
Capacity - Drying	2.5 kg dry laundry
Voltage	see data plate
Connected load	see data plate
Fuse rating	see data plate / plug
Consumption data	see "Consumption data"
Water flow pressure minimum	100 kPa (1 bar)
Water flow pressure maximum	1000 kPa (10 bar)
Inlet hose length	1.60 m
Drain hose length	1.50 m
Connection cable length	1.60 m
Drain pump head max.	1.00 m
Drain pump length max.	5.00 m
Lamp for drum lighting	Type G4 (5 watts/12 volts)
Test certificates awarded	Radio / TV suppression, VDE

The Settings menu is used to alter the machine's electronics to suit changing requirements. Settings can be altered at any time.

Language

The display can be set via the Language sub-menu to appear in one of several different languages.

To open the **Settings** menu

- 1 Switch on the machine. The main menu will appear.

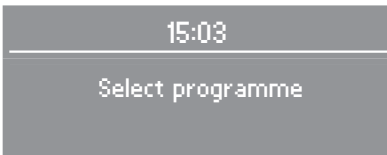

- 2 After a few seconds an additional line will appear in the display.

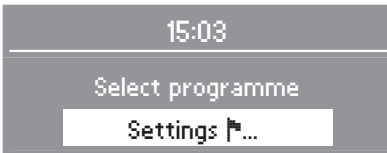

- 3 Confirm your selection by pressing the **OK** button.
- 4 This will take you into the *Settings* menu.

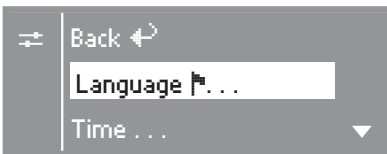

- 5 Use the – and + buttons to select the setting you want and confirm your selection by pressing the **OK** button.

Important:

If you do not make a selection in the Settings menu and in its sub-menus within approx. 20 seconds, the menu display will revert to the main menu.

The flag after the word *Language* acts as a guide to prevent a language which will not be understood from being set.

A tick will appear beside the language to show that it has been set.

- Select the language you want and confirm your selection.

Settings menu

Time of day

You first have to decide whether you want the time to show in the display. Then you have to select either a 24 hour or 12 hour clock.

Then set the current time of day.

To select a 24 hour or 12 hour clock

- Use the **-** and **+** buttons to select the clock option setting you want and confirm your selection by pressing the **OK** button.

The display for setting the time of day will then appear.

To set the time of day

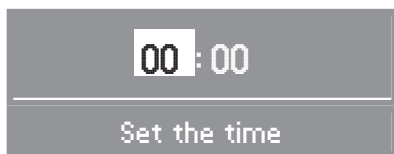

- Set the hour with the **-** and **+** buttons and confirm your setting by pressing the **OK** button. Now set the minutes. The display will return to the *Settings* menu.

The time of day can also be set by pressing the  button before selecting a programme.

Water plus

This setting is used to select the water intake setting for the *Water plus* extra option.

There are three different options:

Water + (the machine is delivered with this option selected)

The water intake is increased in the wash and rinse stages of the programmes.

Extra rinse

An extra rinse is introduced in the *Cottons* and *Minimum iron* programmes.

Water + and Extra rinse

- The water intake is increased in the wash and rinse stages and an additional rinse is also introduced in the *Cottons* and *Minimum iron* programmes.

A tick will appear beside the option to show that it has been set.

Gentle action

Activating gentle action reduces the drum action and is suitable for washing slightly soiled items more gently. It should be activated for garments with a single bar under the care label and for articles which feel too hard after they have been dried.

Gentle action can be activated for the *Cottons* and the *Minimum iron* programmes.

If Gentle action has been activated the wash rhythm will be gentle in all Cottons and Minimum iron programmes.

The machine is delivered with the Gentle action setting deactivated.

A tick will appear beside the option to show that it has been set.

Suds cooling

When this is activated, additional water flows into the drum at the end of the main wash to cool the suds down. Hot suds can damage plastic drainage pipes.

Suds cooling takes place when a *Cottons 95-75°C* programme is selected.

Suds cooling should be activated:

- to prevent the danger of scalding if the drain hose is hooked over the edge of a sink or basin.
- where the drainage pipes do not comply with DIN 1986.

The machine is delivered with Suds cooling deactivated.

A tick will appear beside the option to show that it has been set.

Door release

When this setting is activated the drum door can be opened during a drying programme at temperatures up to 70°C.

If the Door release setting is deactivated, the door can only be opened at temperatures up to 55°C.



Warning: High temperatures can cause burning or scalding.

The machine is delivered with this setting activated.

A tick will appear beside the option to show that it has been set.

- Select the option you want and confirm your selection.

Settings menu

Distribution controller

The maximum final spin speed is limited to prevent the laundry sticking to the drum. (This setting is only available when washing and drying in a continuous sequence).

There are 4 different options:

1200 rpm (factory default setting)

1100 rpm

1000 rpm

900 rpm.

A tick will appear beside the option to show that it has been set.

Alter time

The machine is designed to dry effectively using as little energy as possible. However, it is possible to lengthen or shorten the drying time by up to 4 minutes.

The machine is delivered with the drying time on setting 3 (= 0 minutes).

Lock

The system lock prevents your machine being used without your knowledge.

When the system lock has been activated, you have to enter a code after switching the machine on. Otherwise the machine cannot be operated.

To activate the lock

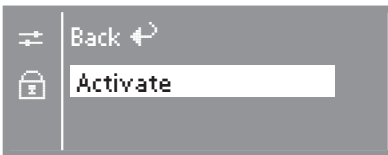

- Select *Activate* and confirm your selection.
- The display will now request that a code is entered. The code is **125** and cannot be altered.

To enter the lock code

The code is: **125**



- Use the **+** button to enter the first number. Confirm your selection of this number by pressing the **OK** button. Now set the second number.
- Repeat the process until all three numbers have been entered.

- After the last number has been entered, press the **OK** button.



- Confirm the code with the **OK** button or if you want to correct a mistake, press the **-** button.
- The lock will now be activated when the machine is switched off.

To unlock the washer-dryer

When the machine is switched on again, the display will request the lock code.

- Enter lock code 125 as described above and confirm the entry.



The machine is now unlocked.

To deactivate the lock

Proceed as for activating the lock.

Settings menu

Temperature

You can choose for the temperature to be displayed as °C/*Celsius* or °F/*Fahrenheit*.

A tick will appear beside the option to show that it has been set.

- Select the option you want and confirm your selection.

Buzzer

When the buzzer function has been activated, an audible tone sounds at the end of a programme or when Rinse hold is reached.

There are two volumes.

Normal (the machine is delivered with this option selected)

The buzzer sounds at the end of a programme or when Rinse hold is reached.

Loud

The buzzer sounds at maximum volume at the end of a programme or when Rinse hold is reached.

A tick will appear beside the option to show that it has been set.

- Select the option you want and confirm your selection.

Keypad tones

An audible tone sounds each time a button is pressed.

The machine is delivered with the keypad tone switched off.

A tick will appear beside the option to show that it has been set.

Display contrast

There are ten different display contrast settings.

The machine is delivered with the display contrast on setting 5.

The display contrast will change as soon as a different setting is chosen.

- Set the display contrast you require.

Display brightness

There are ten different display brightness settings.

The machine is delivered with the display brightness on setting 5.

The display brightness will change as soon as a different setting is chosen.

- Set the display brightness you require.

Standby

To save energy, the display goes out after 10 minutes and the indicator light for the *Start/Stop* button will start flashing slowly.

There are two options:

On

Standby is activated:

- if a programme is not selected after the machine has been switched on.
- after a programme has started.
- at the end of a programme.

Not in current Prog. (the machine is delivered with this option selected)

Standby is activated:

- if a programme is not selected after the machine has been switched on.
- at the end of a programme.

Pressing one of the buttons switches the display back on again.

A tick will appear beside the option to show that it has been set.

Memory

If an extra option has been selected for a programme, or the recommended spin speed has been altered, the machine will store the changes in memory at the start of a programme.

When this programme is chosen again these settings will appear in the display.

The machine is delivered with the memory function deactivated.

A tick will appear beside the option to show that it has been set.

Set extended cool-down

The cooling down phase which takes place before the end of a programme can be lengthened if required. This makes the garments easier to handle.

The cooling down phase can be lengthened from 0 min (standard cooling down phase = default setting) to 18 minutes.

The programme duration will increase accordingly.

To close the Settings menu

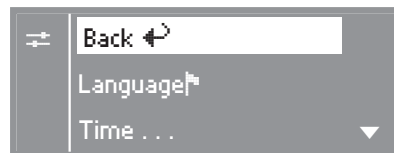

- Select *Back* and confirm your selection.



United Kingdom

Miele Co. Ltd.
Fairacres, Marcham Road
Abingdon, Oxon, OX14 1TW
Tel: (01235) 554455
Fax: (01235) 554477
Customer Contact Centre Tel: (08707) 554466
E-mail: info@miele.co.uk
Internet: www.miele.co.uk

Australia

Miele Australia Pty. Ltd.
A.C.N. 005635398
1 Gilbert Park Drive, Knoxfield, VIC 3180
Tel: (03) 9764 7130
Fax: (03) 9764 7149
Internet: www.miele.com.au

China

Miele Shanghai Rep. Office
Room 4105 - 6, 41 Floor
Plaza 66, 1266 Nan-Jing Road/ West
Shanghai 200040
Tel: +86 21 6288 4200
Fax: +86 21 6288 4100
E-mail: mieleshanghai@cn.miele.com
Internet: www.miele.cn

Hong Kong

Miele (Hong Kong) Limited
AIA Plaza, 24 Floor
18 Hysan Avenue
Causeway Bay
Tel: +852- 2610-1331
Fax: +852-2610-1013
E-mail: mielehk@miele.com.hk
Internet: www.miele.hk

Ireland

Miele Ireland Ltd.
Broomhill Road, Tallaght, Dublin 24
Tel: (01) 461 0710
Fax: (01) 461 07 97
E-Mail: info@miele.ie
Internet: www.miele.ie

New Zealand

Miele New Zealand Limited
Unit L, 10-20 Sylvia Park Road
Mt. Wellington, 1060, Auckland, NZ
Tel: 0800 264353
Fax: 0800 463453
Internet: www.miele.co.nz

South Africa

Miele (Pty) Ltd
63 Peter Place, Bryanston 2194
P.O. Box 69434, Bryanston 2021
Tel: +27 (0) 11 548-1900
Fax: +27 (0) 11 548-1935
E-mail: info@miele.co.za
Internet: www.miele.co.za

Singapore

Miele Southeast Asia
Miele Pte. Ltd.
163 Penang Road
04 - 02/03 Winsland House II
Singapore 238463
Tel: +65 6735 1191
Fax: +65 6735 1161
E-Mail: infosea@miele.com.sg
Internet: www.miele.sg

United Arab Emirates

Miele Appliances Ltd.
P.O. Box 11 47 82
Gold & Diamond Park
Sheikh Zayed Road
Building 6 / Offices Nos. 6-214 to 6-220
Dubai
Tel: +971-4-341 84 44
Fax: +971-4-341 88 52
E-Mail: info@miele.ae
Internet: www.miele.ae